

Multi-Photon and Entangled-Photon Imaging and Lithography

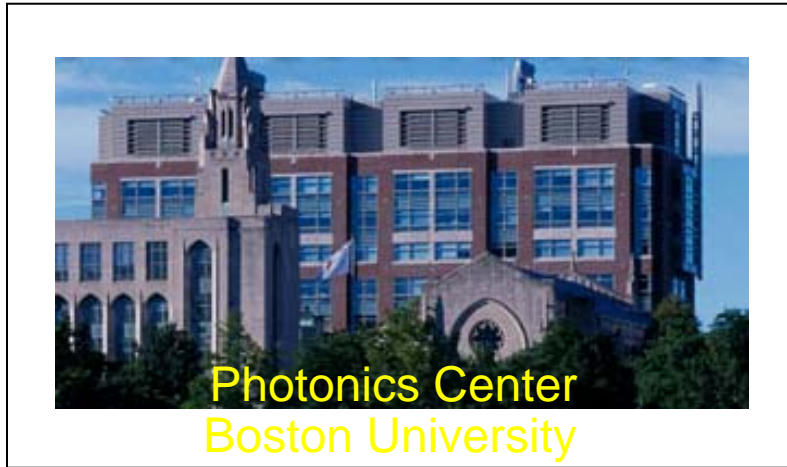

Malvin Carl Teich

College of Optics & Photonics
University of Central Florida

Columbia & Boston Universities

<http://people.bu.edu/teich>

Photons Arrive Randomly

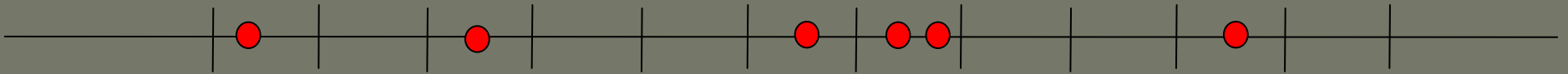

Product of photon-number and phase uncertainties:

$$\Delta n \Delta \phi = 1/2$$

Multiphoton Excitation VS Entangled-Photon Excitation



Optics & Photonics News 11, 40 (2000)

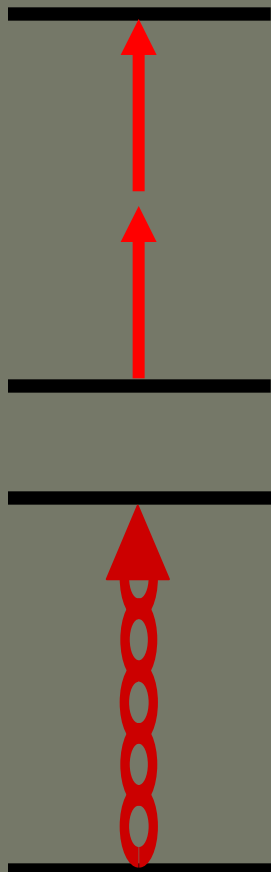

- For classical light, probability of simultaneous absorption of n photons $\propto I^n$
- Multiphoton absorption more likely in regions of high light intensity
- Ultrafast light pulses have high peak intensities, allowing multiphoton excitation at low average power
- Excitation (photoemission, fluorescence, lithography, photochemistry), can be localized for n photons
- For entangled- n -photon light, probability of simultaneous absorption of n photons $\propto I$

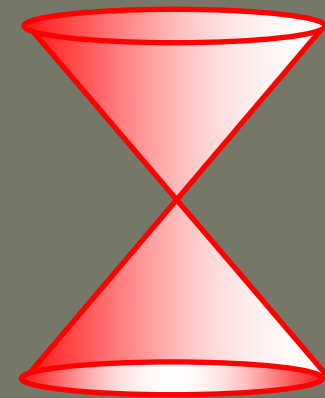
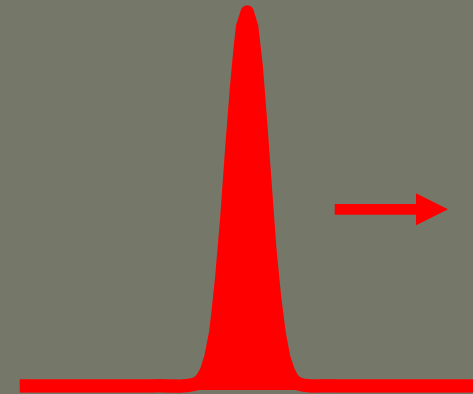

Generation of Entangled Photon Pairs via Spontaneous Parametric Down-Conversion

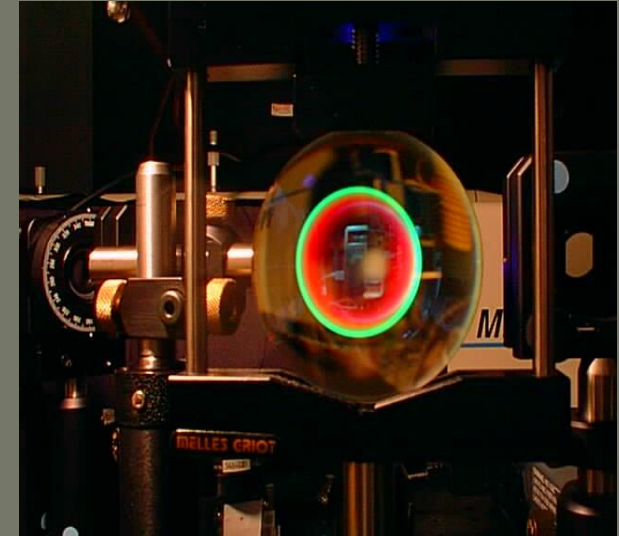
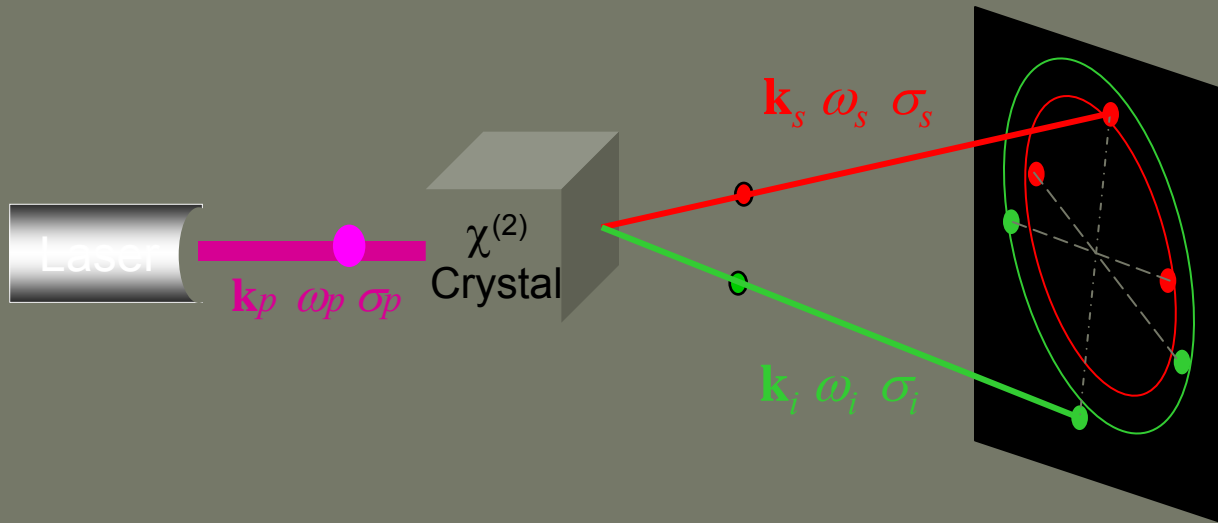

ENERGY CONSERVATION: $\omega_p = \omega_s + \omega_i$

MOMENTUM CONSERVATION: $\mathbf{k}_p = \mathbf{k}_s + \mathbf{k}_i$

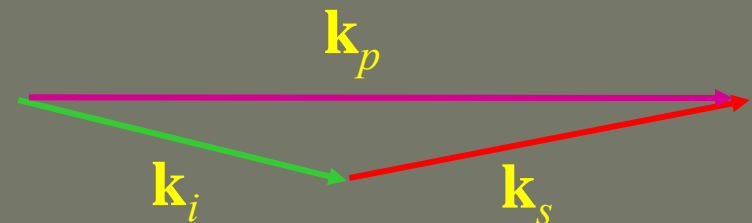

PHOTONS ARE EMITTED IN PAIRS (TWINS):

- Each at a random time, but times are correlated : $t_s - t_i = \tau = \text{const}$
- Each is broadband, but frequencies are anti-correlated : $\omega_s + \omega_i = \omega_p = \text{const}$
- Each is multidirectional, but directions are anti-correlated : $\mathbf{k}_s + \mathbf{k}_i = \mathbf{k}_p = \text{const}$
- Each with random polarization, but polarizations are orthogonal : (Type-II SPDC)

IDEAL

REAL

$$t_s - t_i = \tau = \text{const}$$

$$\Delta\tau \equiv \tau_e$$

$$\omega_s + \omega_i = \omega_p = \text{const}$$

$$\Delta\omega_p$$

$$\mathbf{k}_s + \mathbf{k}_i = \mathbf{k}_p = \text{const}$$

$$\Delta\mathbf{k} \equiv A_e$$

After Joobeur, Saleh, and Teich, "Spatiotemporal Coherence Properties of Entangled Light Beams Generated by Parametric Down-Conversion," *Phys. Rev. A* **50**, 3349 (1994)

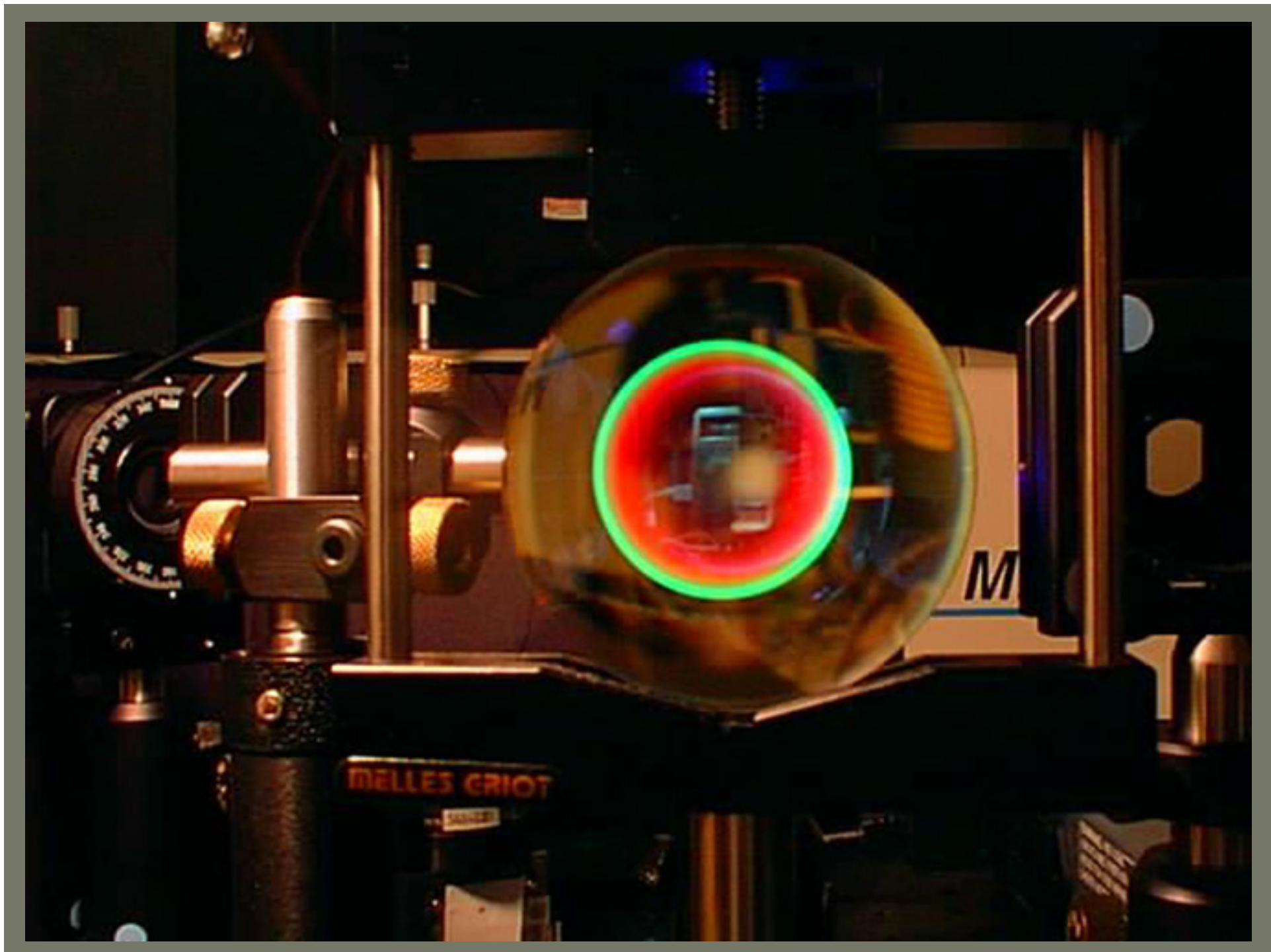

EXAMPLES

Multiphoton

◆ Absorption

T: Göppert-Mayer (1931)

E: Franken *et al.* (1961)

◆ Photoemission

T: Bloch (1964)

E: Teich & Wolga (1964)

◆ Microscopy

T: Sheppard & Kompfner (1978)

E: Denk *et al.* (1990)

◆ Lithography

T: ancient

E: 3D..Maruo & Kawata (1997)

◆ OCT (Optical Coherence Tomography – Single Photon)

T: Youngquist *et al.* (1987)

E: Huang *et al.* (1991)

Entangled-Photon

◆ Absorption

T: Fei *et al.* (1997)

E: Dayan *et al.* (2004)

◆ Photoemission

T: Lissandrin *et al.* (2004)

E:

◆ Microscopy

T: Teich & Saleh (1997)

E:

◆ Lithography

T: Boto *et al.* (2000)

E:

◆ QOCT (Quantum Optical Coherence Tomography – 2-Photon)

T: Abouraddy *et al.* (2002)

E: Nasr *et al.* (2003)

EXAMPLES

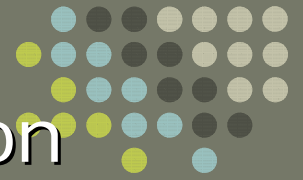

Multiphoton

- ◆ **Absorption**
T: Göppert-Mayer (1931)
E: Franken *et al.* (1961)
- ◆ **Photoemission**
T: Bloch (1964)
E: Teich & Wolga (1964)
- ◆ **Microscopy**
T: Sheppard & Kompfner (1978)
E: Denk *et al.* (1990)
- ◆ **Lithography**
T: ancient
E: 3D..Maruo & Kawata (1997)
- ◆ **OCT (Optical Coherence Tomography – Single Photon)**
T: Youngquist *et al.* (1987)
E: Huang *et al.* (1991)

Entangled-Photon

- ◆ **Absorption**
T: Fei *et al.* (1997)
E: Dayan *et al.* (2004)
- ◆ **Photoemission**
T: Lissandrin *et al.* (2004)
E:
- ◆ **Microscopy**
T: Teich & Saleh (1997)
E:
- ◆ **Lithography**
T: Boto *et al.* (2000)
E:
- ◆ **QOCT (Quantum Optical Coherence Tomography – 2-Photon)**
T: Abouraddy *et al.* (2002)
E: Nasr *et al.* (2003)

Second-Harmonic Generation (SHG)



VOLUME 7, NUMBER 4

PHYSICAL REVIEW LETTERS

AUGUST 15, 1961

GENERATION OF OPTICAL HARMONICS*

P. A. Franken, A. E. Hill, C. W. Peters, and G. Weinreich

The Harrison M. Randall Laboratory of Physics, The University of Michigan, Ann Arbor, Michigan

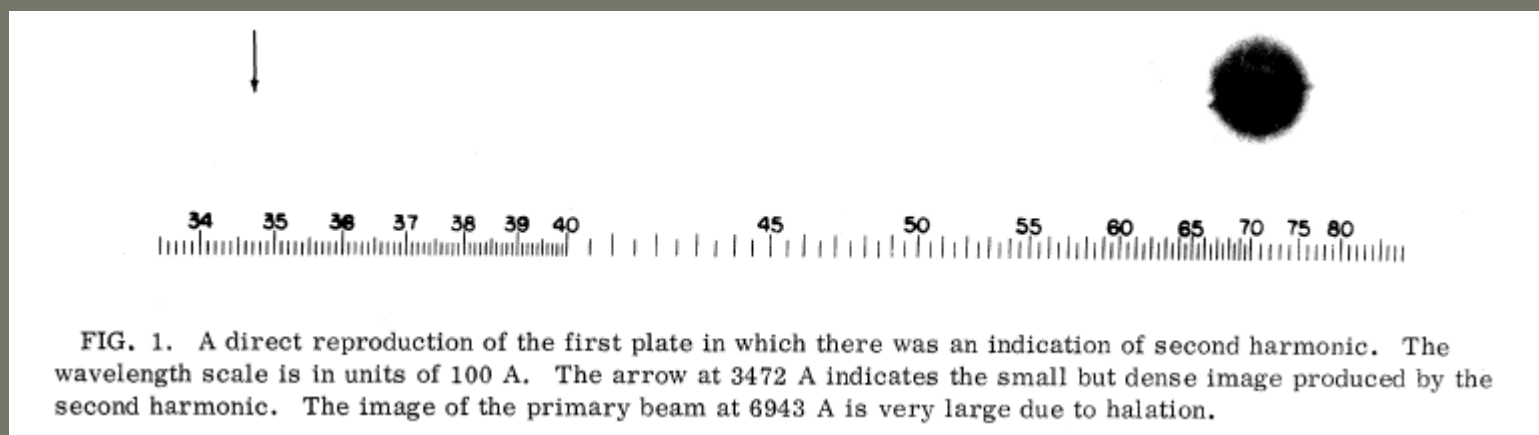

Enhancement of SHG via Thermal Light or Speckle

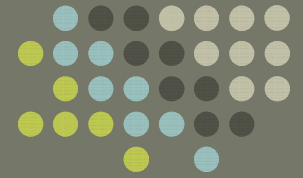

Volume 2, number 5

OPTICS COMMUNICATIONS

October 1970

PHOTON-CORRELATION ENHANCEMENT OF SHG AT 10.6 μm

M. C. TEICH *

Department of Electrical Engineering, Columbia University, New York, New York 10027, USA

and

R. L. ABRAMS and W. B. GANDRUD

Bell Telephone Laboratories, Incorporated, Whippany, New Jersey 07981, USA

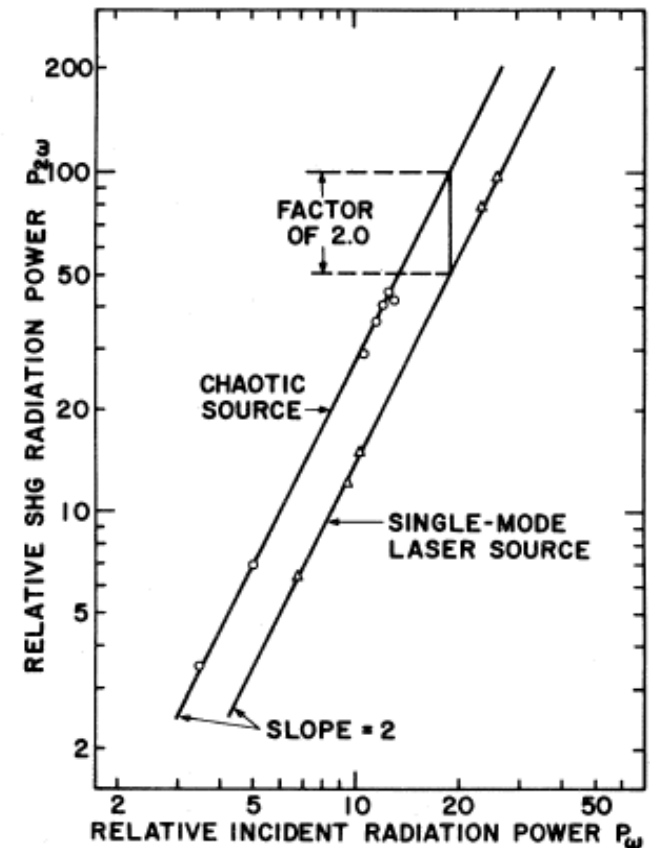
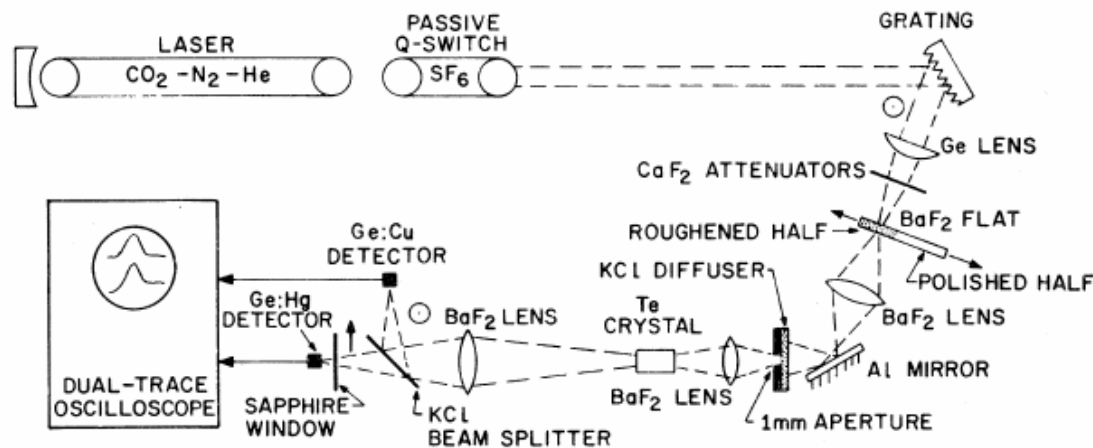

Entangled-Photon Absorption (Theory)

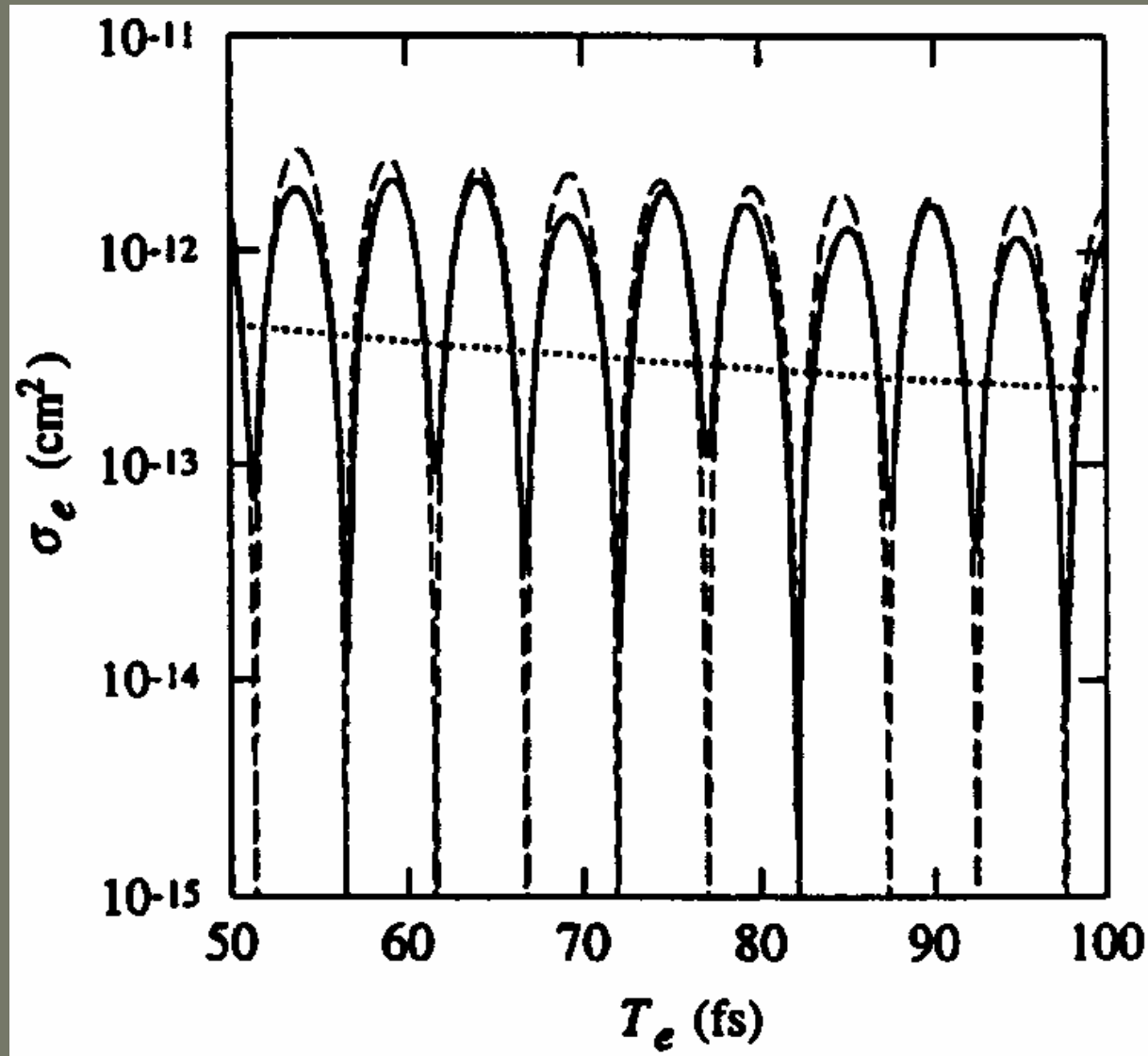
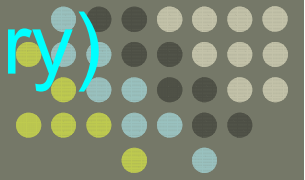

After Fei, Jost, Popescu, Saleh, and Teich, "Entanglement-Induced Two-Photon Transparency,"
Phys. Rev. Lett. 78, 1679 (1997)

Entangled-Photon SFG (Experiment)

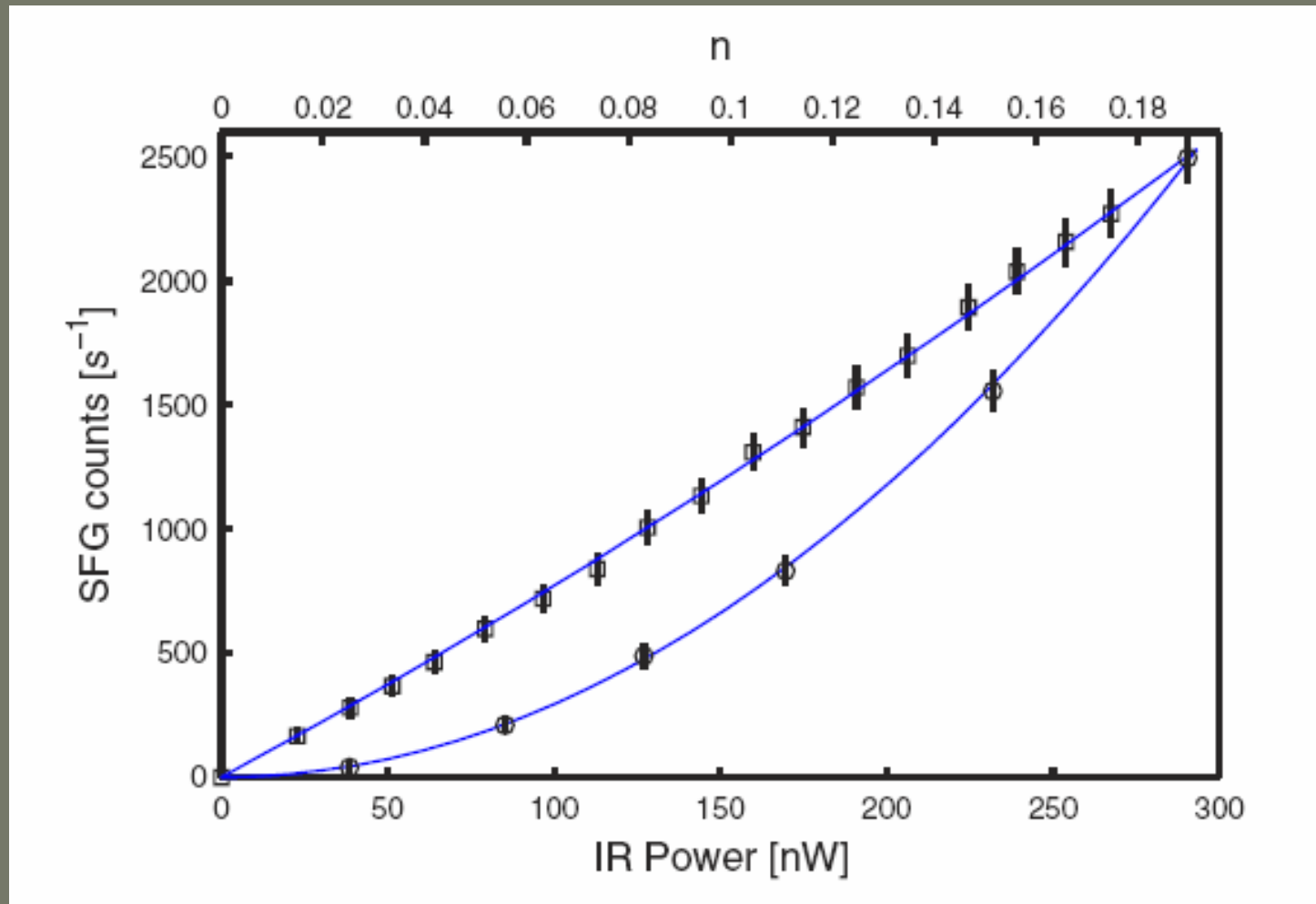
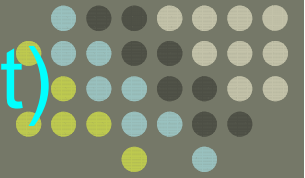

After Dayan, Pe'er, Friesem, and Silberberg, "Nonlinear Interactions with an Ultrahigh Flux of Broadband Entangled Photons,"
Phys. Rev. Lett. **94**, 043602 (2005)

NONLINEAR AND ENTANGLED-PHOTON IMAGING

Linear Optics

◆ Scalar

$$d = \frac{\lambda}{2n \sin \alpha}$$

◆ Super-resolution

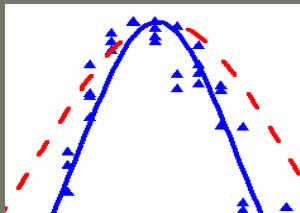

◆ Vector beam

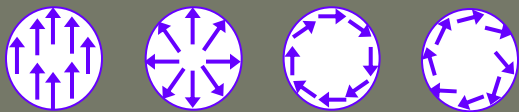

Nonlinear Optics

◆ Phase conjugation

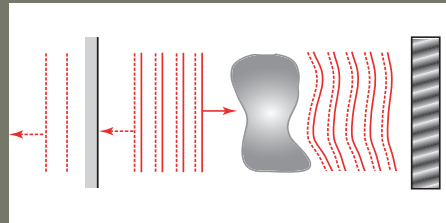

◆ STED (stimulated emission depletion microscopy)

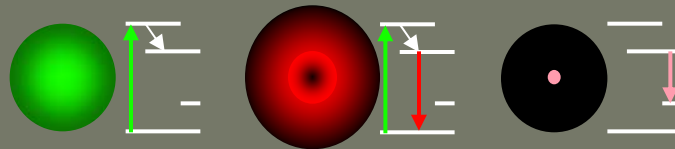

◆ Multiphoton imaging

Quantum Optics

◆ Quadrature-squeezed imaging

◆ Number-squeezed imaging

◆ Entangled-photon imaging

Optical Imaging = Extracting the spatial distribution of a remote object (static or dynamic, 2D or 3D, scalar or vector, B/W or color).

EXAMPLES

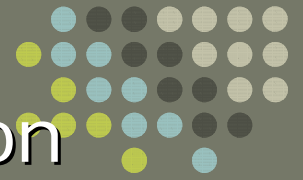

Multiphoton

- ◆ **Absorption**
T: Göppert-Mayer (1931)
E: Franken *et al.* (1961)
- ◆ **Photoemission**
T: Bloch (1964)
E: Teich & Wolga (1964)
- ◆ **Microscopy**
T: Sheppard & Kompfner (1978)
E: Denk *et al.* (1990)
- ◆ **Lithography**
T: ancient
E: 3D..Maruo & Kawata (1997)
- ◆ **OCT** (Optical Coherence Tomography – Single Photon)
T: Youngquist *et al.* (1987)
E: Huang *et al.* (1991)

Entangled-Photon

- ◆ **Absorption**
T: Fei *et al.* (1997)
E: Dayan *et al.* (2004)
- ◆ **Photoemission**
T: Lissandrin *et al.* (2004)
E:
- ◆ **Microscopy**
T: Teich & Saleh (1997)
E:
- ◆ **Lithography**
T: Boto *et al.* (2000)
E:
- ◆ **QOCT** (Quantum Optical Coherence Tomography – 2-Photon)
T: Abouraddy *et al.* (2002)
E: Nasr *et al.* (2003)

Multiphoton Microscopy

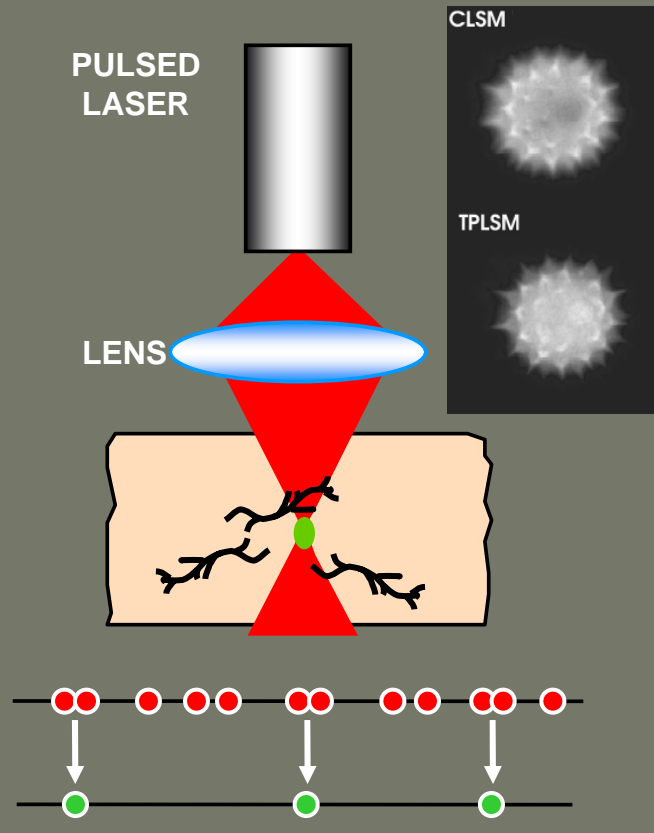

ADVANTANGES: Longer wavelength source penetrates more deeply into tissue. Excitation only occurs only at focal region – eliminates pinhole detectors, increases SNR, and provides optical sectioning capabilities.

DISADVANTAGES: Large photon flux is required. Samples must have broad upper-energy levels. Expensive titanium:sapphire laser system. Sample photodamage.

Entangled-Photon Microscopy

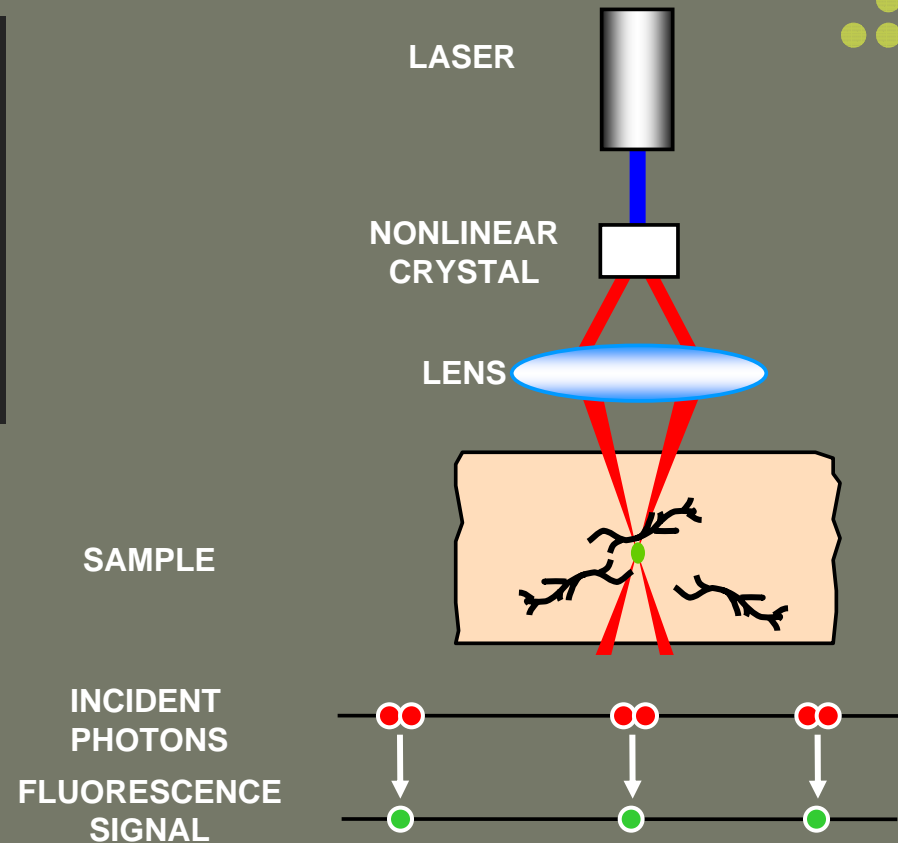

ADVANTANGES: Guaranteed photon pairs create comparable depth penetration but at substantially reduced light levels. Samples do not require broad upper-energy levels. Pump laser can be continuous-wave or pulsed.

DISADVANTAGES: Overall photon flux is low. Entangled-photon absorption cross-section and entanglement area are not well established.

After Teich and Saleh, "Mikroskopie s kvantově provázanými fotony (Entangled-Photon Microscopy)," *Československý časopis pro fyziku* 47, 3 (1997)
U.S. Patent 5,796,477 (issued 18 August 1998)

EXAMPLES

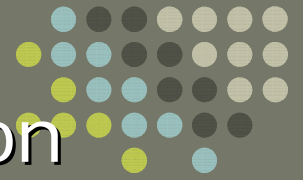

Multiphoton

- ◆ **Absorption**
T: Göppert-Mayer (1931)
E: Franken *et al.* (1961)
- ◆ **Photoemission**
T: Bloch (1964)
E: Teich & Wolga (1964)
- ◆ **Microscopy**
T: Sheppard & Kompfner (1978)
E: Denk *et al.* (1990)
- ◆ **Lithography**
T: ancient
E: 3D..Maruo & Kawata (1997)
- ◆ **OCT** (Optical Coherence Tomography – Single Photon)
T: Youngquist *et al.* (1987)
E: Huang *et al.* (1991)

Entangled-Photon

- ◆ **Absorption**
T: Fei *et al.* (1997)
E: Dayan *et al.* (2004)
- ◆ **Photoemission**
T: Lissandrin *et al.* (2004)
E:
- ◆ **Microscopy**
T: Teich & Saleh (1997)
E:
- ◆ **Lithography**
T: Boto *et al.* (2000)
E:
- ◆ **QOCT** (Quantum Optical Coherence Tomography – 2-Photon)
T: Abouraddy *et al.* (2002)
E: Nasr *et al.* (2003)

Entangled-Photon Lithography (Theory)

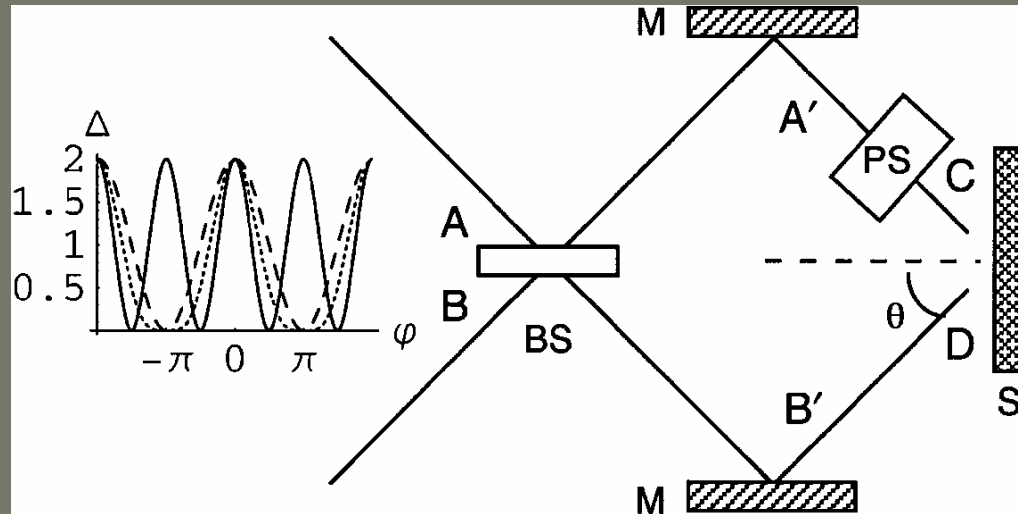

After Boto, Kok, Abrams, Braunstein, Williams, and Dowling, “Quantum Interferometric Optical Lithography: Exploiting Entanglement to Beat the Diffraction Limit,” *Phys. Rev. Lett.* 85, 2733 (2000)

Origin of factor of 2 resolution enhancement and validity for arbitrary masks:

PRL 94, 223601 (2005)

PHYSICAL REVIEW LETTERS

week ending
10 JUNE 2005

Wolf Equations for Two-Photon Light

Bahaa E. A. Saleh,* Malvin C. Teich, and Alexander V. Sergienko

Quantum Imaging Laboratory[†], Departments of Electrical & Computer Engineering and Physics, Boston University,

Boston, Massachusetts 02215-2421, USA

(Received 13 December 2004; published 7 June 2005)

The spatiotemporal two-photon probability amplitude that describes light in a two-photon entangled state obeys equations identical to the Wolf equations, which are satisfied by the mutual coherence function for light in any quantum state. Both functions therefore propagate similarly through optical systems. A generalized van Cittert–Zernike theorem explains the predicted enhancement in resolution for entangled-photon microscopy and quantum lithography. The Wolf equations provide a particularly powerful analytical tool for studying three-dimensional imaging and lithography since they describe propagation in continuous inhomogeneous media.

3D Lithography

Example: Radical Multiphoton Absorption Polymerization

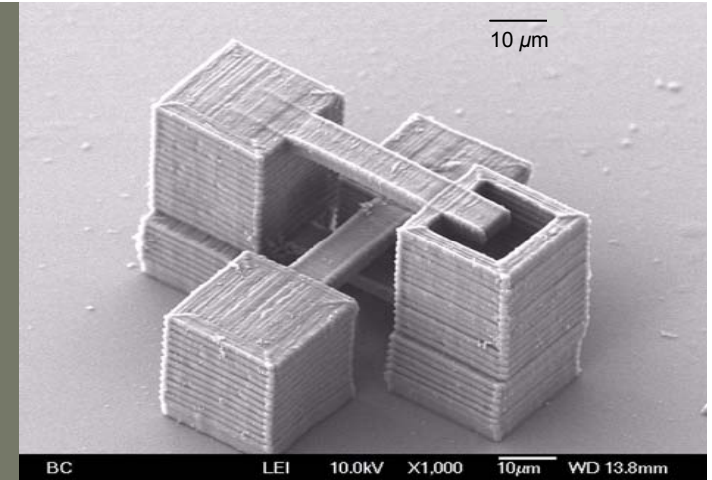

- Multiphoton absorption by a photo-initiator in a viscous liquid pre-polymer resin generates radicals. (A co-initiator may be required as well.)
- Photoexcitation of the photo-initiator begins a chain reaction that hardens the resin locally.
- Theoretical resolution available via multiphoton absorption (MPA) inversely proportional to the numerical aperture.
- Chemical nonlinearity (quenching of radicals by oxygen or recombination) can lead to a substantial increase in resolution via thresholding.

After Baldacchini, LaFratta, Farrer, Teich, Saleh, Naughton, and Fourkas, "Acrylic-Based Resin with Favorable Properties for Three-Dimensional Two-Photon Polymerization,"

J. Appl. Phys. **95**, 6072 (2004)

Selective Functionalization of 3-D Polymer Microstructures

Richard A. Farrer,[†] Christopher N. LaFratta,^{†,‡} Linjie Li,^{†,‡} Julie Praino,[§] Michael J. Naughton,[¶]
Bahaa E. A. Saleh,[§] Malvin C. Teich,[§] and John T. Fourkas^{*,†,‡}

Eugene F. Merkert Chemistry Center, and the Department of Physics, Boston College, Chestnut Hill, Massachusetts 02467, Department of Chemistry & Biochemistry, University of Maryland, College Park, Maryland 20742, and Department of Electrical & Computer Engineering, Boston University, Boston, Massachusetts 02215

J. AM. CHEM. SOC. ■ VOL. 128, NO. 6, 2006 1797

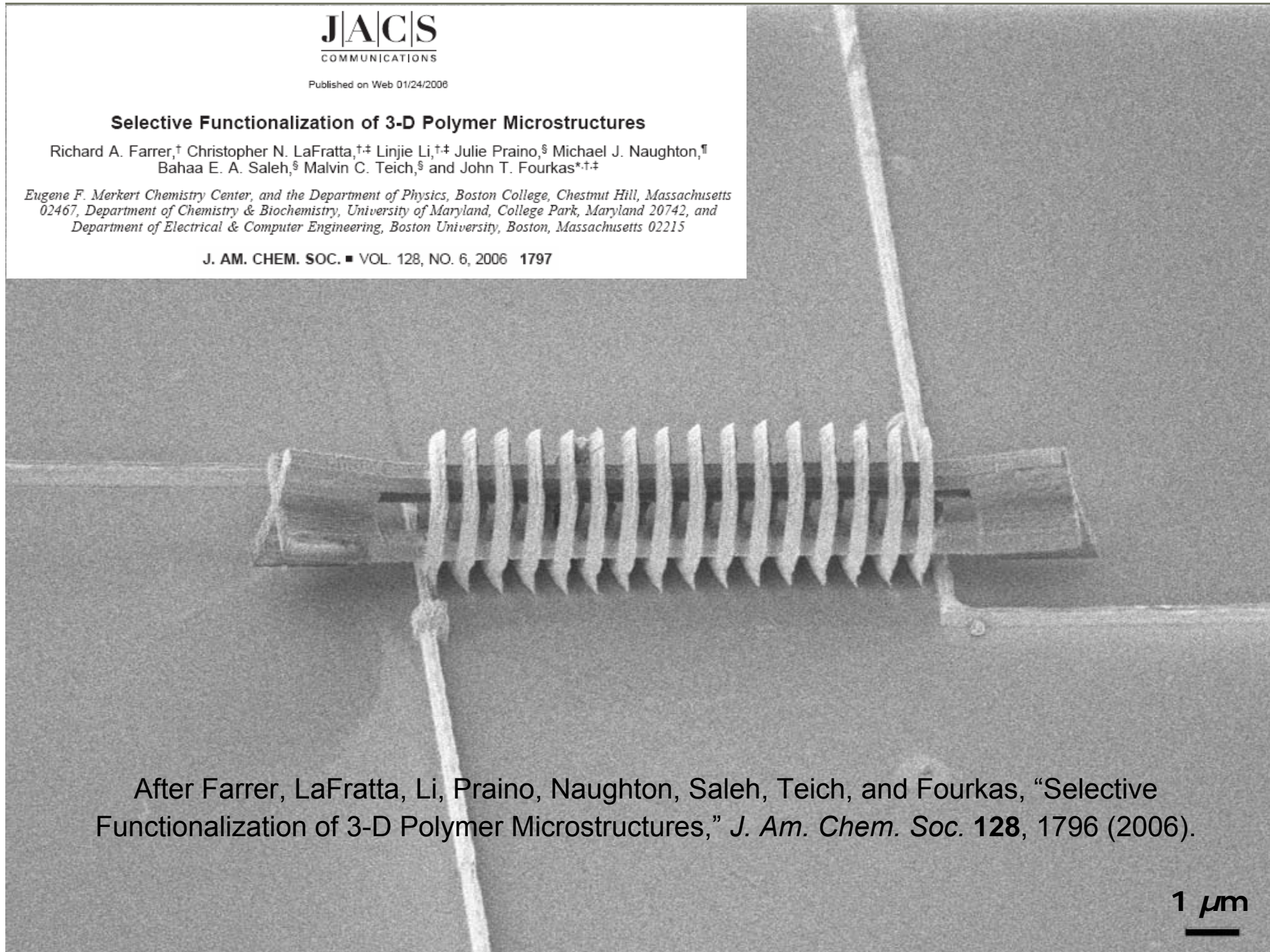

After Farrer, LaFratta, Li, Praino, Naughton, Saleh, Teich, and Fourkas, "Selective Functionalization of 3-D Polymer Microstructures," *J. Am. Chem. Soc.* **128**, 1796 (2006).

1 μm
—

EXAMPLES

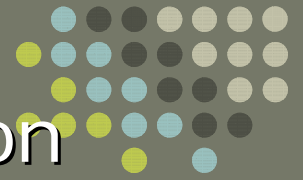

Multiphoton

- ◆ **Absorption**
T: Göppert-Mayer (1931)
E: Franken *et al.* (1961)
- ◆ **Photoemission**
T: Bloch (1964)
E: Teich & Wolga (1964)
- ◆ **Microscopy**
T: Sheppard & Kompfner (1978)
E: Denk *et al.* (1990)
- ◆ **Lithography**
T: ancient
E: 3D..Maruo & Kawata (1997)
- ◆ **OCT (Optical Coherence Tomography – Single Photon)**
T: Youngquist *et al.* (1987)
E: Huang *et al.* (1991)

Entangled-Photon

- ◆ **Absorption**
T: Fei *et al.* (1997)
E: Dayan *et al.* (2004)
- ◆ **Photoemission**
T: Lissandrin *et al.* (2004)
E:
- ◆ **Microscopy**
T: Teich & Saleh (1997)
E:
- ◆ **Lithography**
T: Boto *et al.* (2000)
E:
- ◆ **QOCT (Quantum Optical Coherence Tomography – 2-Photon)**
T: Abouraddy *et al.* (2002)
E: Nasr *et al.* (2003)

Classical Optical Coherence Tomography (OCT)

OCT = Interferometric reflectometry using a broadband source of light (short coherence length)

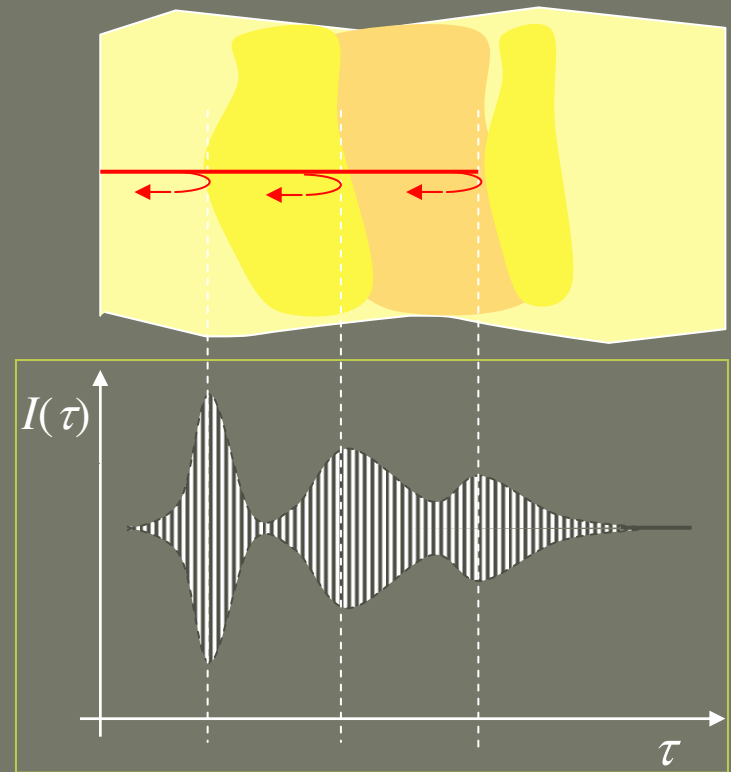
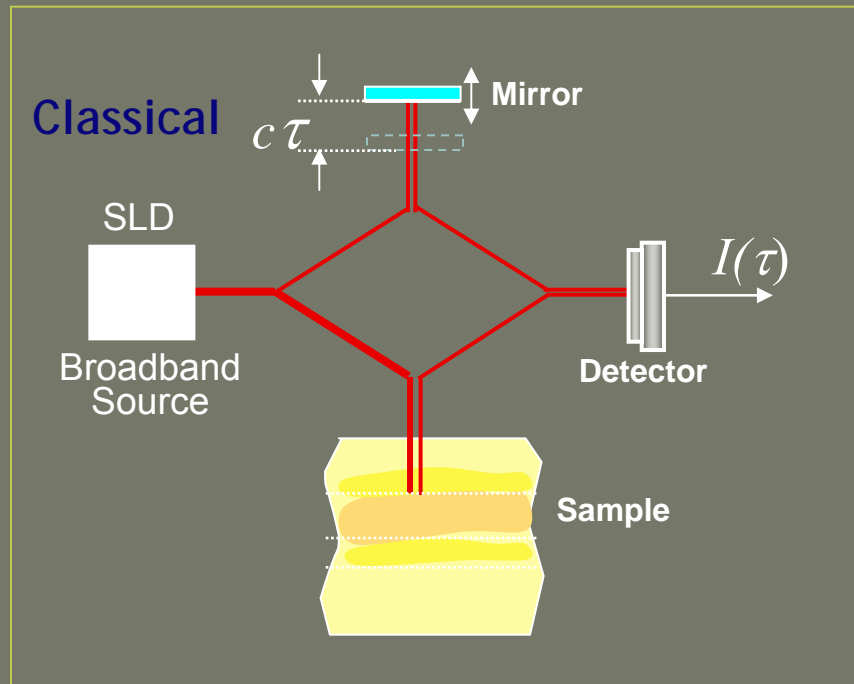

Axial resolution is often of the order of a few μm

Submicron resolution is possible with fs lasers and supercontinuum light

In a dispersive medium, the resolution deteriorates to tens of μm

See Youngquist, Carr, and Davies, "Optical coherence-domain reflectometry: A new optical evaluation technique," Opt. Lett. **12**, 158–160 (1987).

Quantum Optical Coherence Tomography (QOCT)



= OCT based on quantum interferometry of spectrally-entangled photons generated by downconverted light from a nonlinear crystal

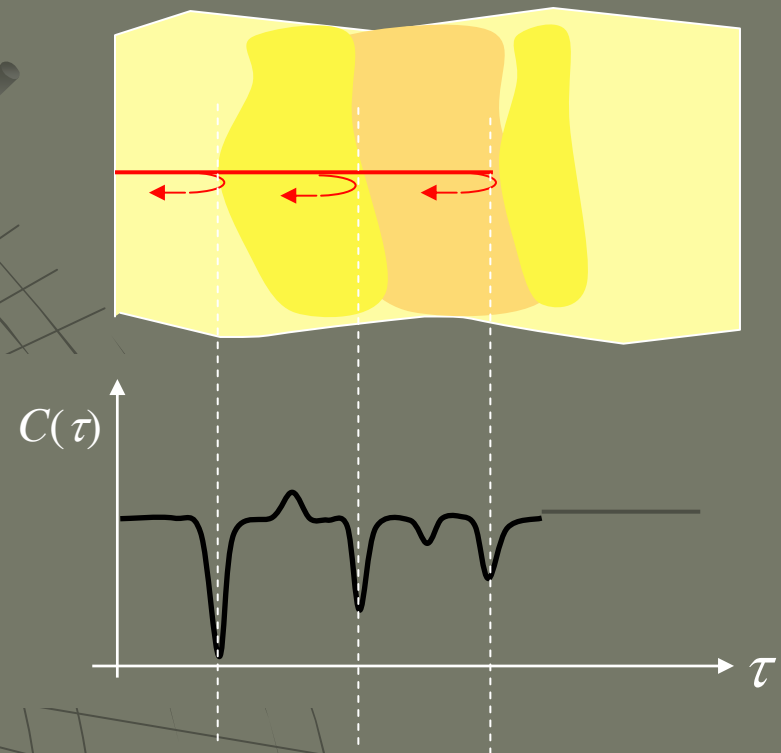
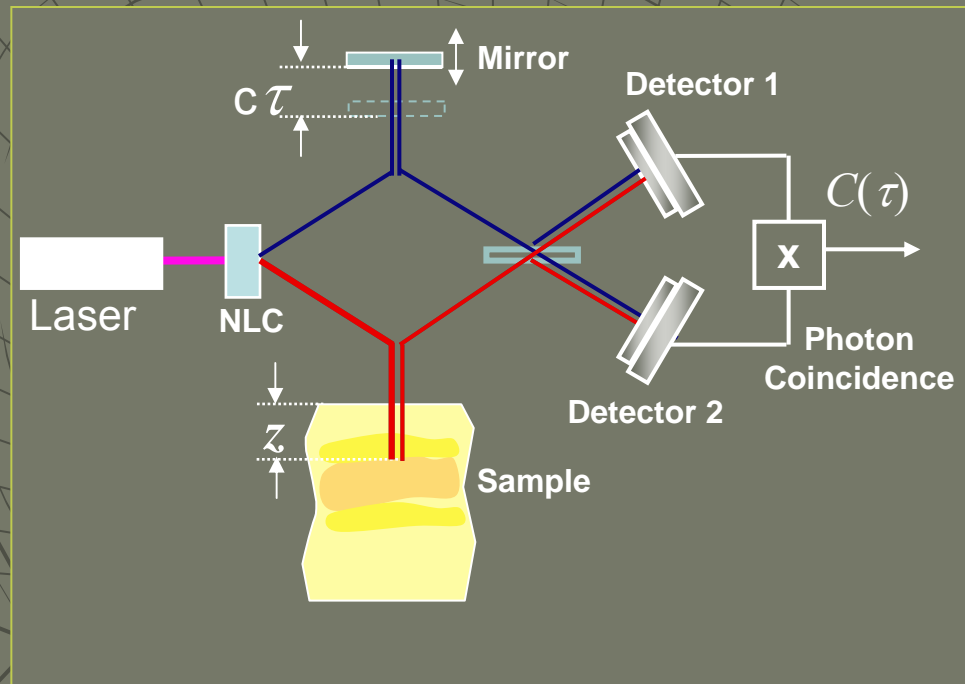

Advantages of QOCT:

- ❑ Factor of 2 improvement in axial resolution for same spectral width
- ❑ Insensitivity to group-velocity dispersion w. concomitant improvement in axial resolution

After Abouraddy, Nasr, Saleh, Sergienko, and Teich, "Quantum-Optical Coherence Tomography with Dispersion Cancellation," *Phys. Rev. A* **65**, 053817 (2002)

Indistinguishability Yields Interference

There are four possible photon paths at the beamsplitter: RT, TR, RR, and TT. For indistinguishable photons, the RR and TT alternatives cancel by virtue of the π phase shift at the beamsplitter. The remaining RT and TR alternatives yield both photons exiting the same port of the beamsplitter (they appear to stick together) so that the probability of photon coincidence is zero.

RR

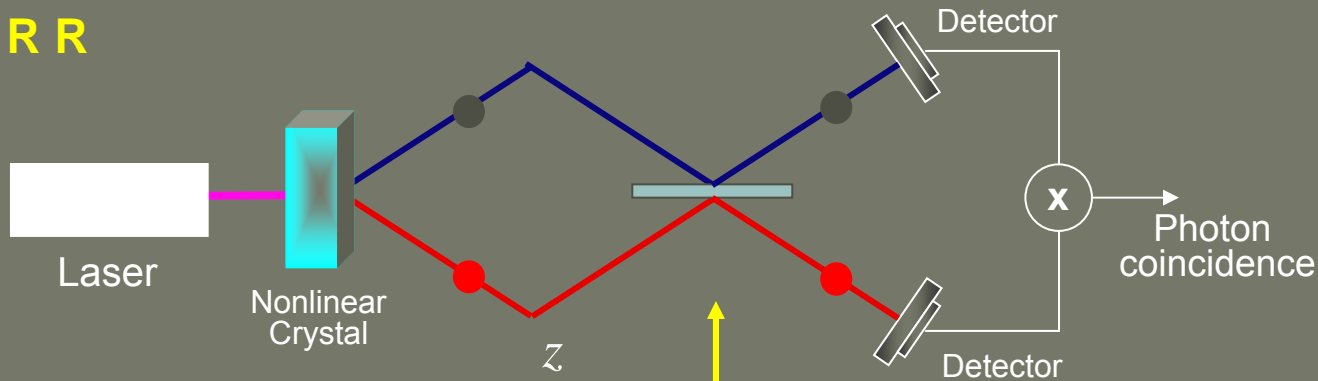

CANCELS

RESULTING IN:

TT

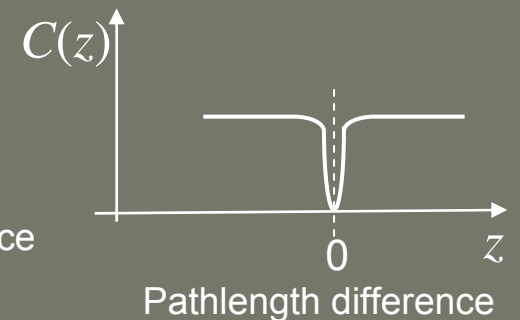
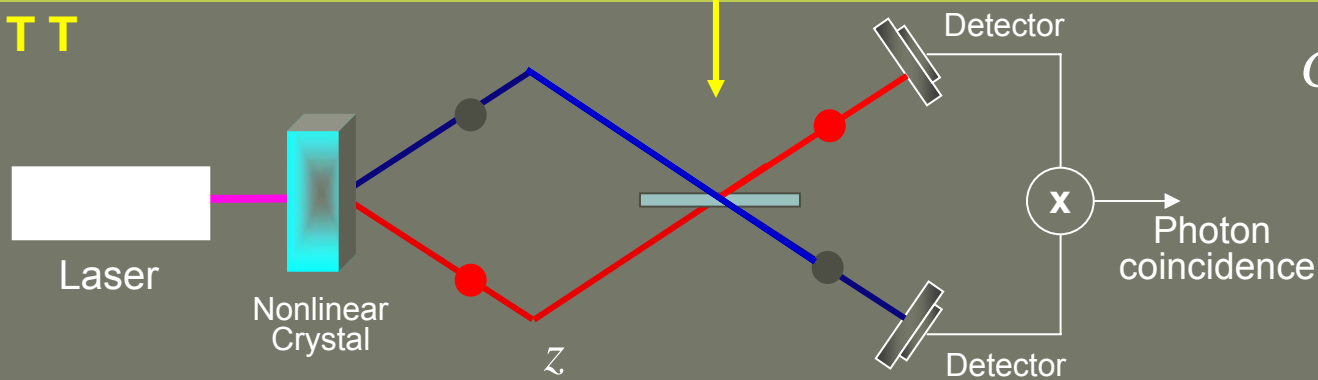

Note that coincidence detection achieves high visibility despite unbalanced loss

C. K. Hong, Z. Y. Ou, and L. Mandel, *Phys. Rev. Lett.* **59**, 2044 (1987)

Dispersion-Free QOCT (Experiment)

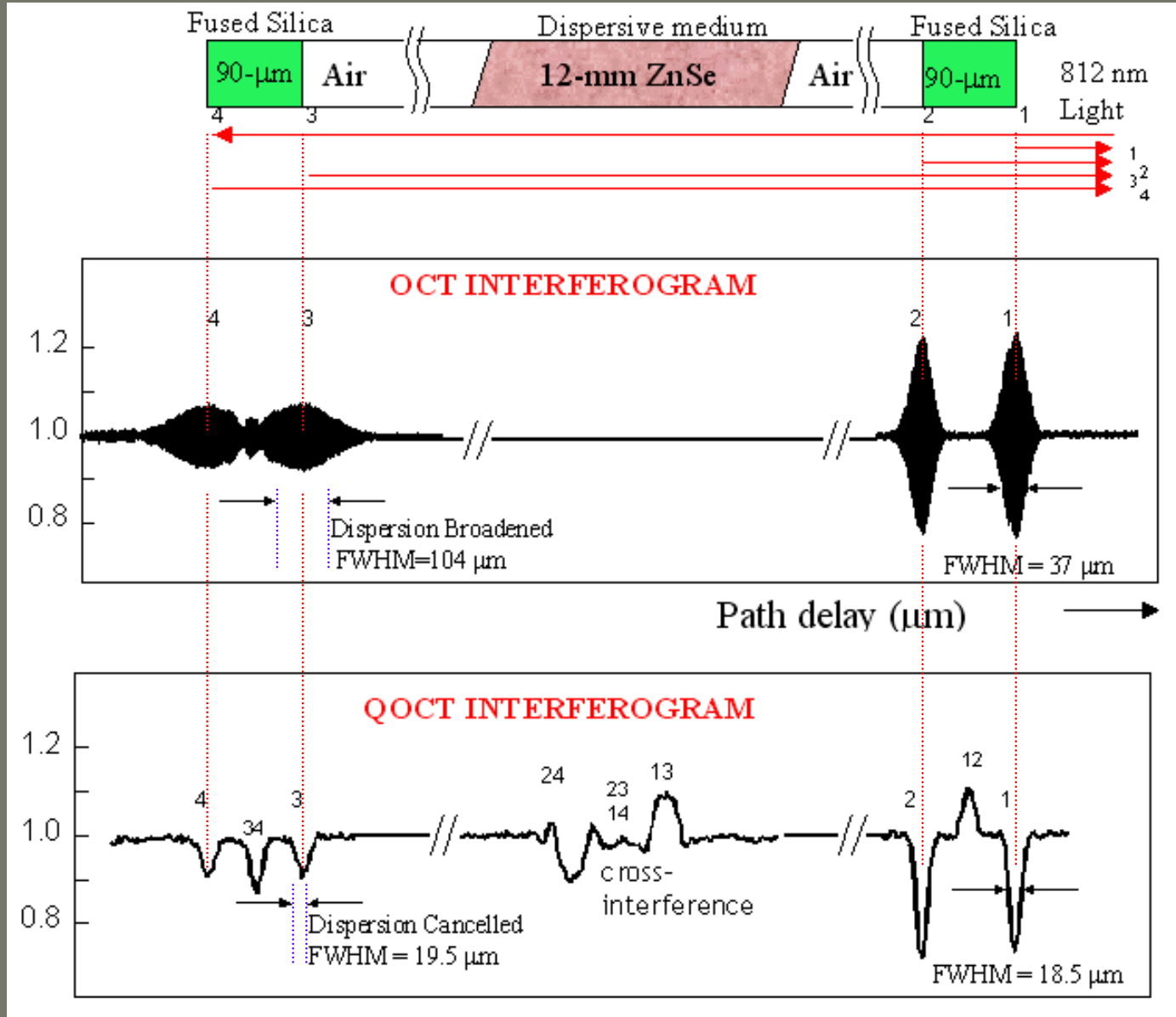

After Nasr, Saleh, Sergienko, and Teich, "Dispersion-Cancelled and Dispersion-Sensitive Quantum Optical Coherence Tomography," *Opt. Express* 12, 1353 (2004)

OCT vs. QOCT

- ❑ Q-OCT promises improved axial resolution in comparison with conventional OCT for sources of same spectral bandwidth
- ❑ Source bandwidth for Q-OCT governed by process of entangled-photon generation (e.g., crystal width); can be tuned
- ❑ Self-interference at each boundary immune to group-velocity dispersion introduced by layers above
- ❑ Inter-boundary interference sensitive to dispersion of inter-boundary layers; dispersion parameters can thus be estimated
- ❑ These first experiments demonstrate viability of technique

QOCT of Onion-Skin Cells in 3D (Experiment)

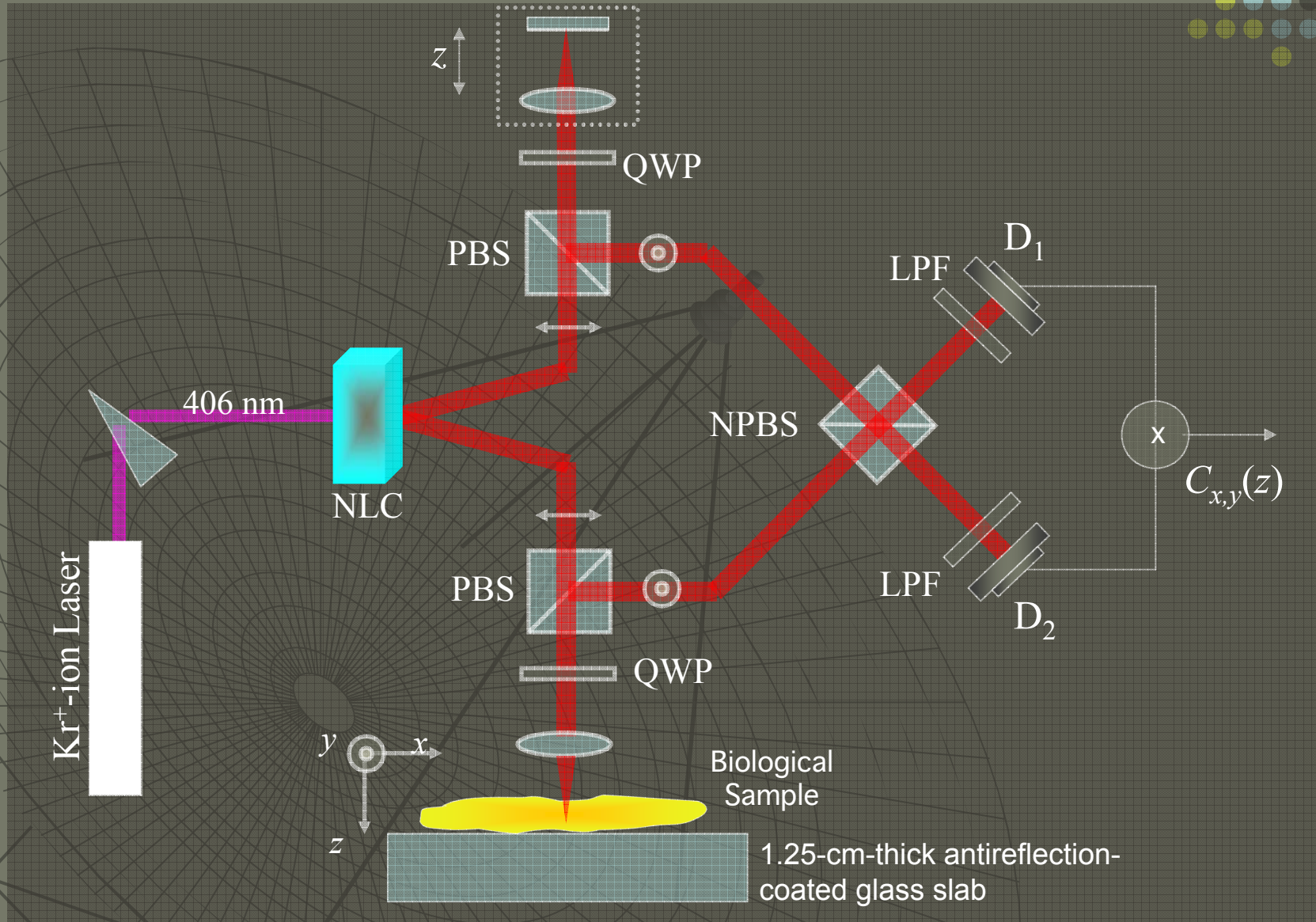

After Nasr, Goode, Nguyen, Rong, Yang, Reinhard, Saleh, and Teich, "Quantum Optical Coherence Tomography of a Biological Sample," *Opt. Commun.* **282**, 1154 (2009).

A-Scan

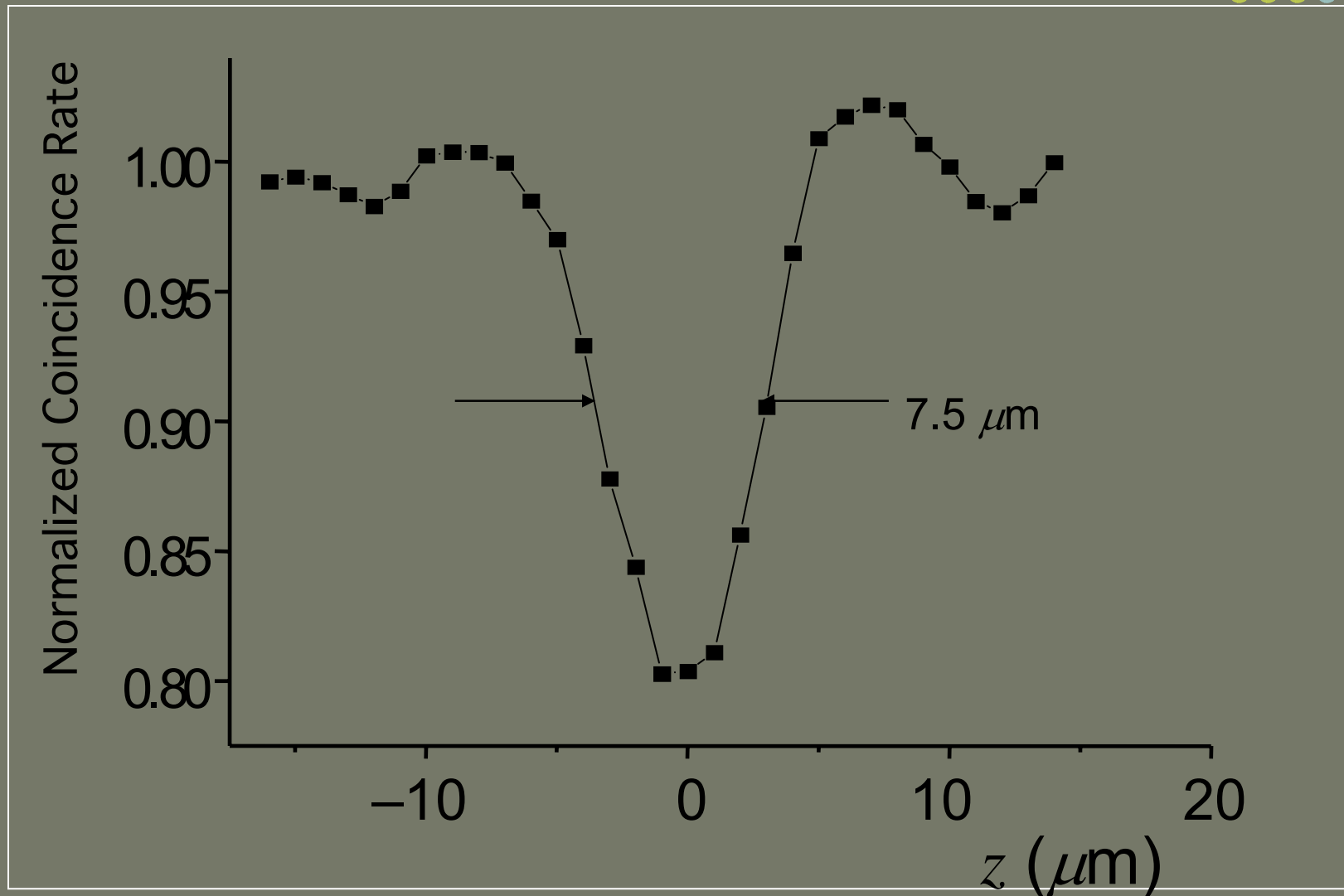
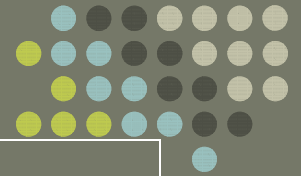

After Nasr, Goode, Nguyen, Rong, Yang, Reinhard, Saleh, and Teich, "Quantum Optical Coherence Tomography of a Biological Sample," *Opt. Commun.* **282**, 1154 (2009).

3D Contours of Constant Coincidence Rate

Sample coated with BSA-functionalized gold nanoparticles

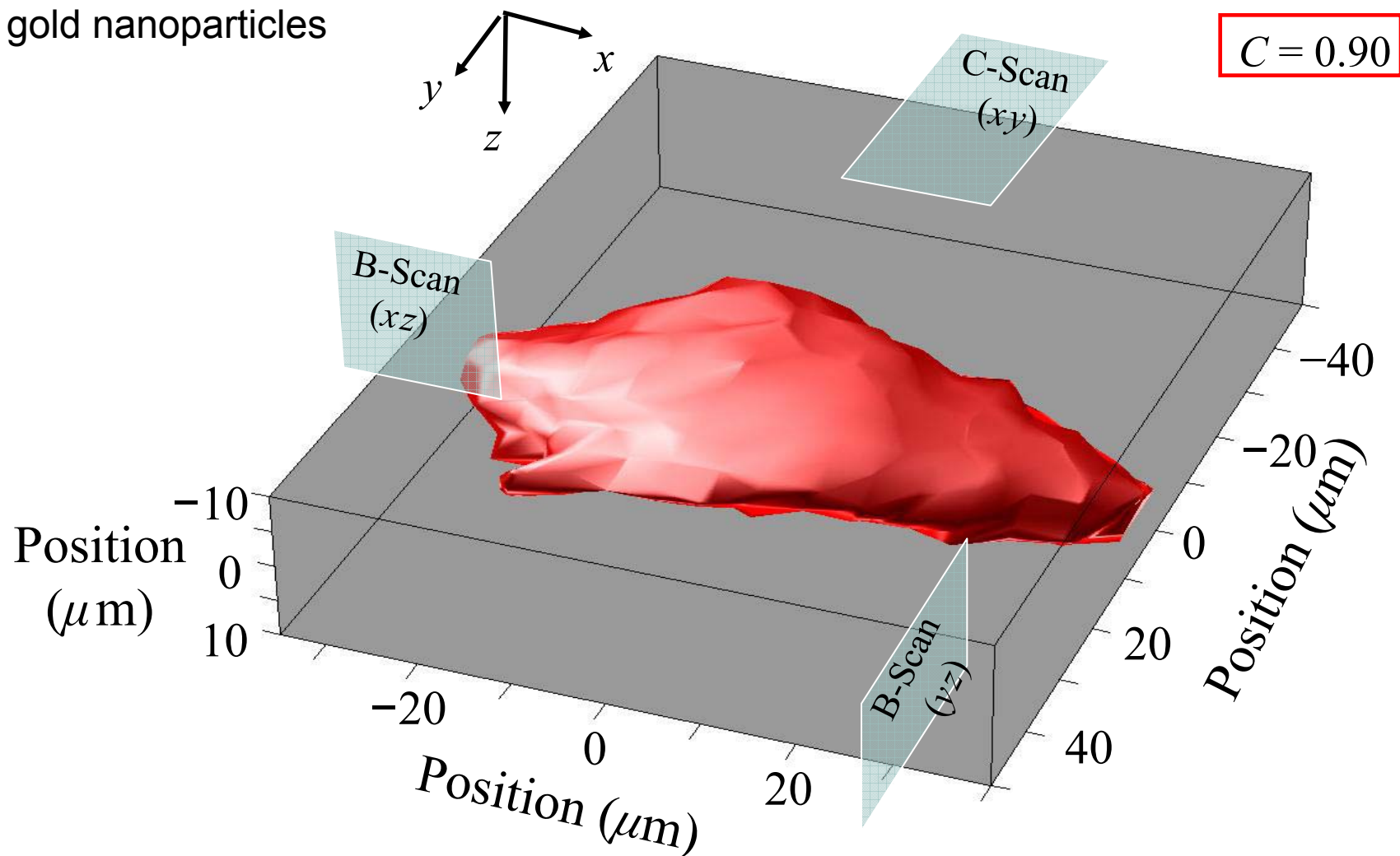

After Nasr, Goode, Nguyen, Rong, Yang, Reinhard, Saleh, and Teich, "Quantum Optical Coherence Tomography of a Biological Sample," *Opt. Commun.* **282**, 1154 (2009).

C-Scans

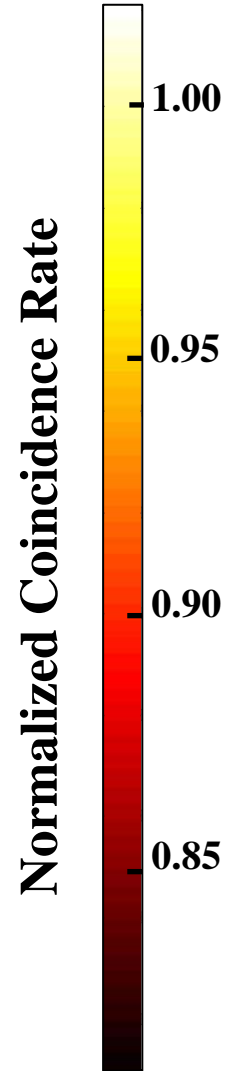
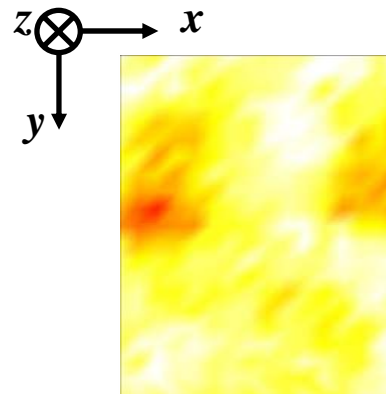
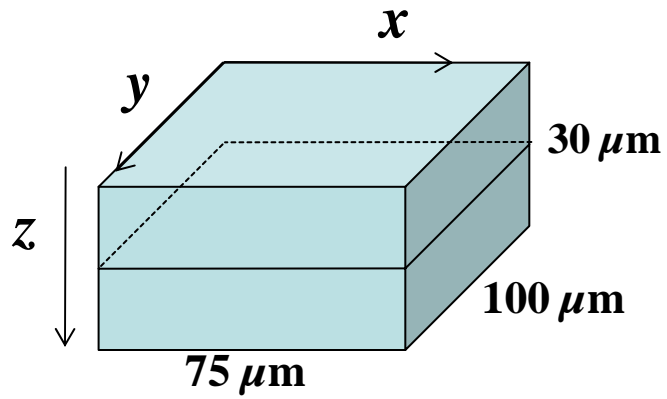

Transverse
resolution
 $12\ \mu\text{m}$

C-Scans

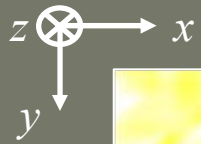

$z = -5 \mu\text{m}$



$-4 \mu\text{m}$

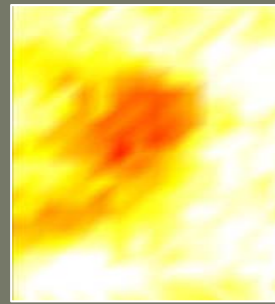

$-3 \mu\text{m}$

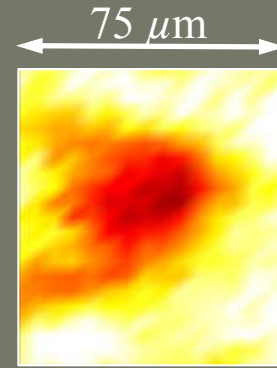

$-2 \mu\text{m}$

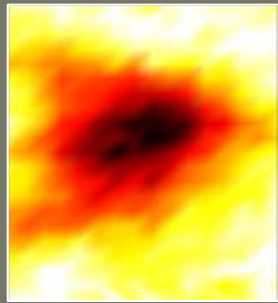

$-1 \mu\text{m}$

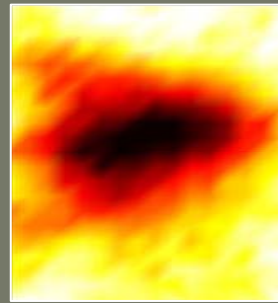

$0 \mu\text{m}$

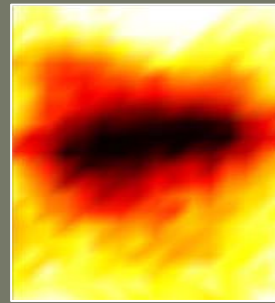

$1 \mu\text{m}$

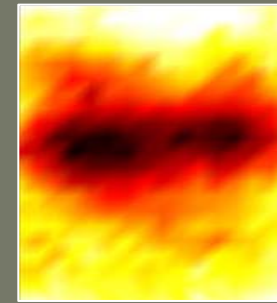

$2 \mu\text{m}$

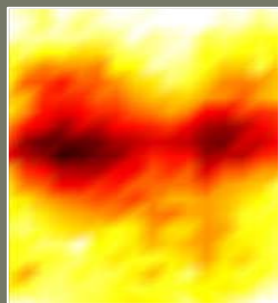

$3 \mu\text{m}$

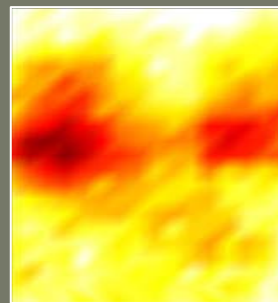

$4 \mu\text{m}$

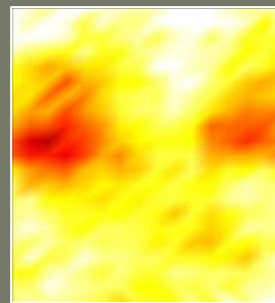

$5 \mu\text{m}$

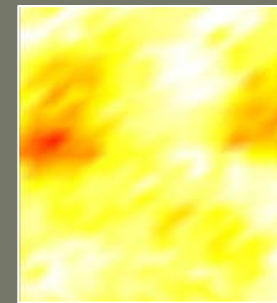

$6 \mu\text{m}$

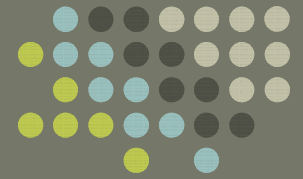

Normalized Coincidence Rate

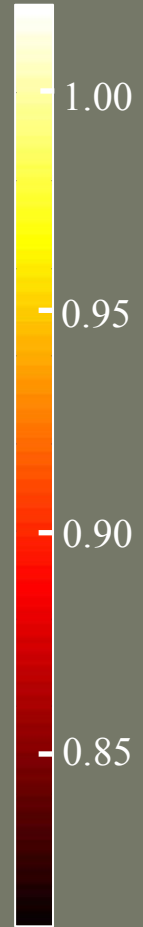

After Nasr, Goode, Nguyen, Rong, Yang, Reinhard, Saleh, and Teich, "Quantum Optical Coherence Tomography of a Biological Sample," *Opt. Commun.* **282**, 1154 (2009).

B-Scans

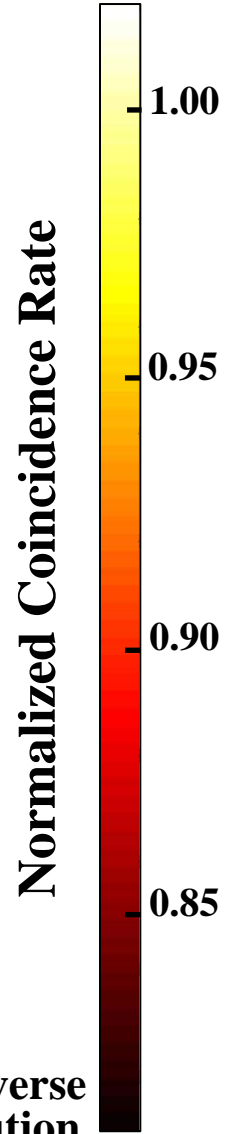
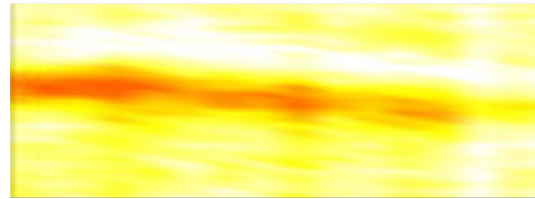
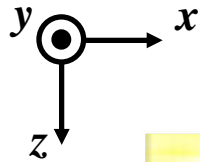
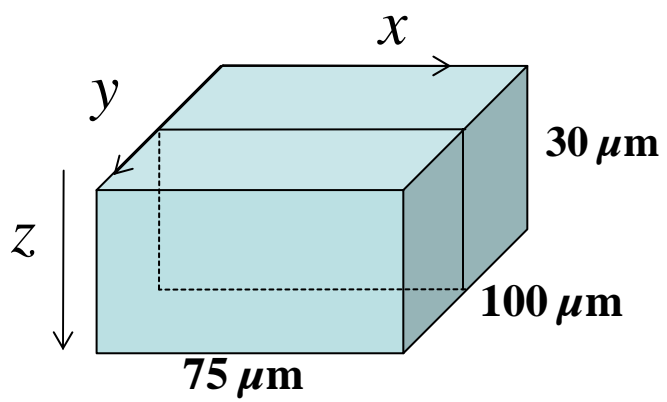

Transverse
resolution
 $12\ \mu\text{m}$

Applications of OCT and QOCT



- Transparent tissue: eye: retinal nerve fiber layer, retinal thickness, contour changes in the optic disk; subcutaneous blood vessels
- Turbid media: vascular wall, plaques
- Polarization-OCT: tissues with collagen or elastin fibers: muscle, tendons; normal and thermally damaged soft tissues

Recent Improvements Enabling Biological QOCT

- Compact optical configuration
- Use of lenses to enhance spatial resolution
- Use of PBS/QWPs to increase photon flux (factor of 4)
- Enhanced sample preparation using gold nanoparticles and BSA

Continuing Challenges for QOCT

- ◆ Limited photon flux: improvement via decreased entanglement time
- ◆ Limited axial resolution: improvement via increased source bandwidth

Biological QOCT: Summary



- ◆ First demonstration of the interaction of a quantum-entangled entity and a biological system (nonplanar, scattering, diffusive medium) — entanglement survived the interaction to create an image
- ◆ Demonstration of the viability of quantum 3D imaging of a biological sample
- ◆ Gold nanoparticles were used to enhance the sample reflectance — a new paradigm for quantum imaging
- ◆ Axial resolution ($7.5 \mu\text{m}$) can be improved to $1 \mu\text{m}$. Transverse resolution ($12 \mu\text{m}$) can be improved
- ◆ Scan time remains too long (but pump power was only 2 mW, corresponding to 0.5 pW of downconverted photons or 10^6 photon pairs/sec)

Further Advances

- ◆ Quasi-phase matched (QPM) downconversion (increased photon flux)
- ◆ Chirped quasi-phase-matched downconversion (increased bandwidth)
- ◆ QOCT resolution enhancement via chirped-QPM downconversion
- ◆ QOCT resolution enhancement via superconducting single-photon detectors
- ◆ Photon-counting OCT (biological) at $\lambda = 1 \mu\text{m}$ using chirped-QPM SPDC
- ◆ Quantum-mimetic implementations of QOCT
- ◆ Entangled-photon generation via guided-wave parametric downconversion
- ◆ Use of ultrafast compression techniques for generic quantum imaging

Quasi-Phase-Matched (QPM) Downconversion

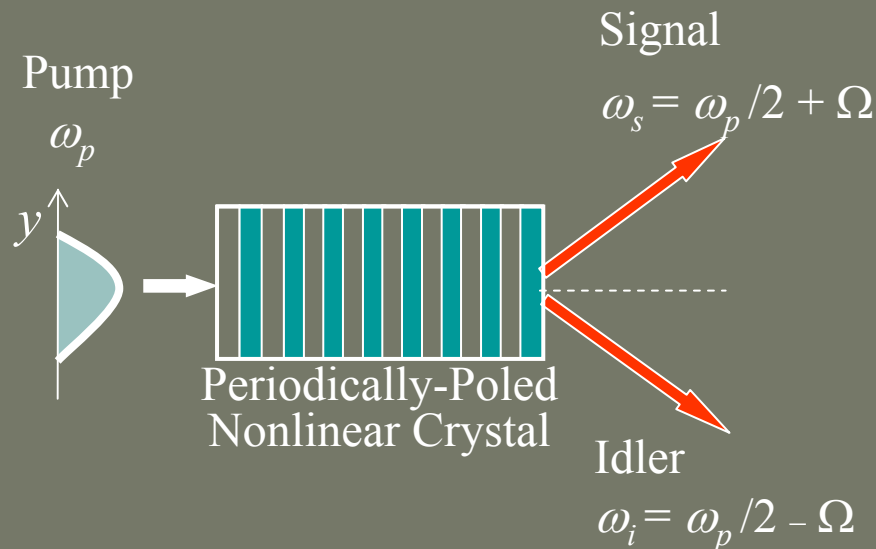

Increased Photon Flux

Chirped Quasi-Phase-Matched (QPM) Downconversion



Increased Spectral Bandwidth

QOCT with Chirped-QPM Downconversion Enhances Resolution

After Carrasco, Torres, Torner, Sergienko, Saleh, and Teich, "Enhancing the Axial Resolution of Quantum Optical Coherence Tomography by Chirped Quasi-Phase-Matching," *Opt. Lett.* **29**, 2429 (2004)

Enhancement of QOCT Resolution via Chirped QPM: 19 μm to 1 μm

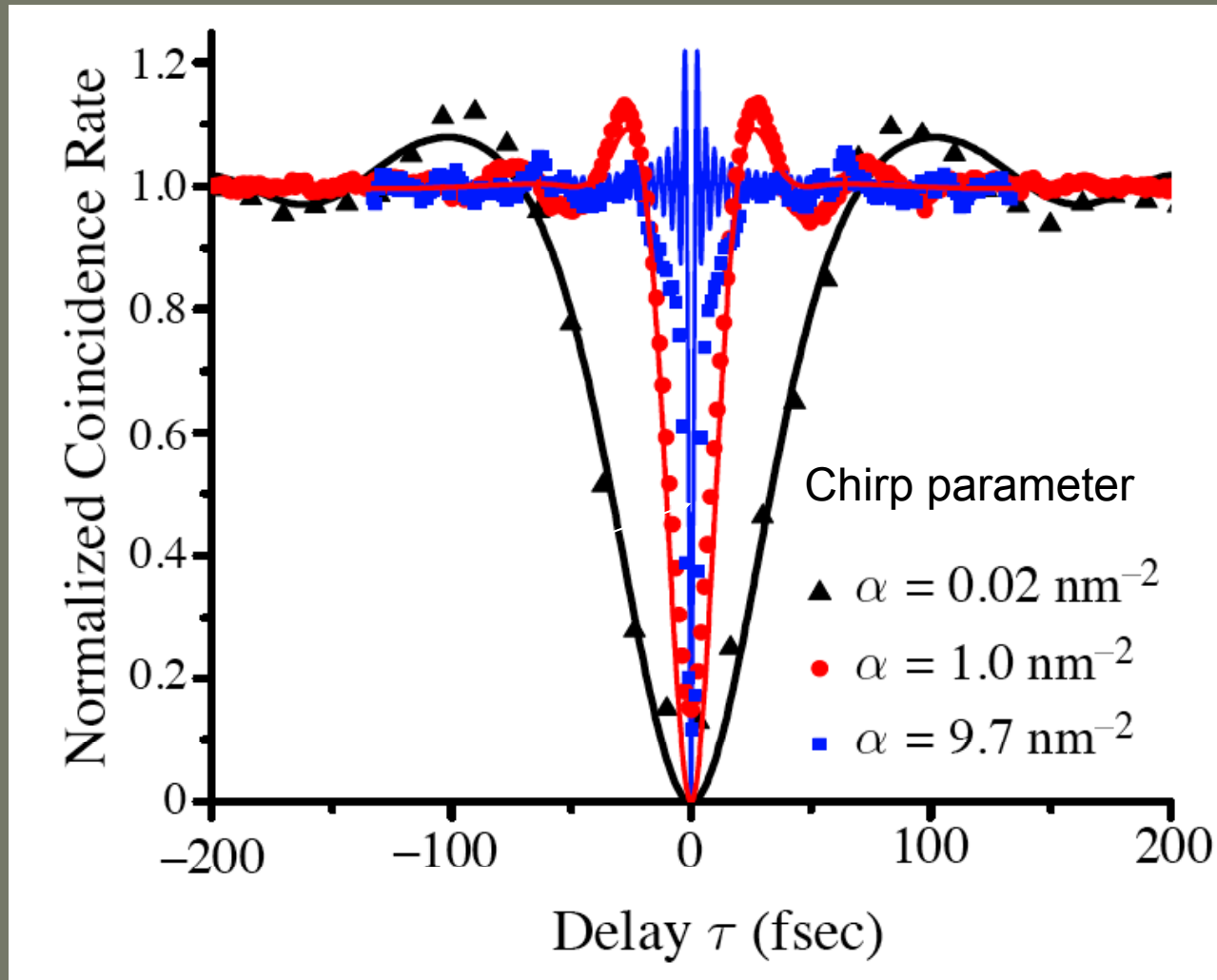

After Nasr, Carrasco, Saleh, Sergienko, Teich, Torres, Torner, Hum, and Fejer, "Ultrabroadband Biphotons Generated via Chirped Quasi-Phase-Matched Optical Parametric Down-Conversion," *Phys. Rev. Lett.* **100**, 183601 (2008)

Enhancement of QOCT Resolution via Increase in Detector Bandwidth

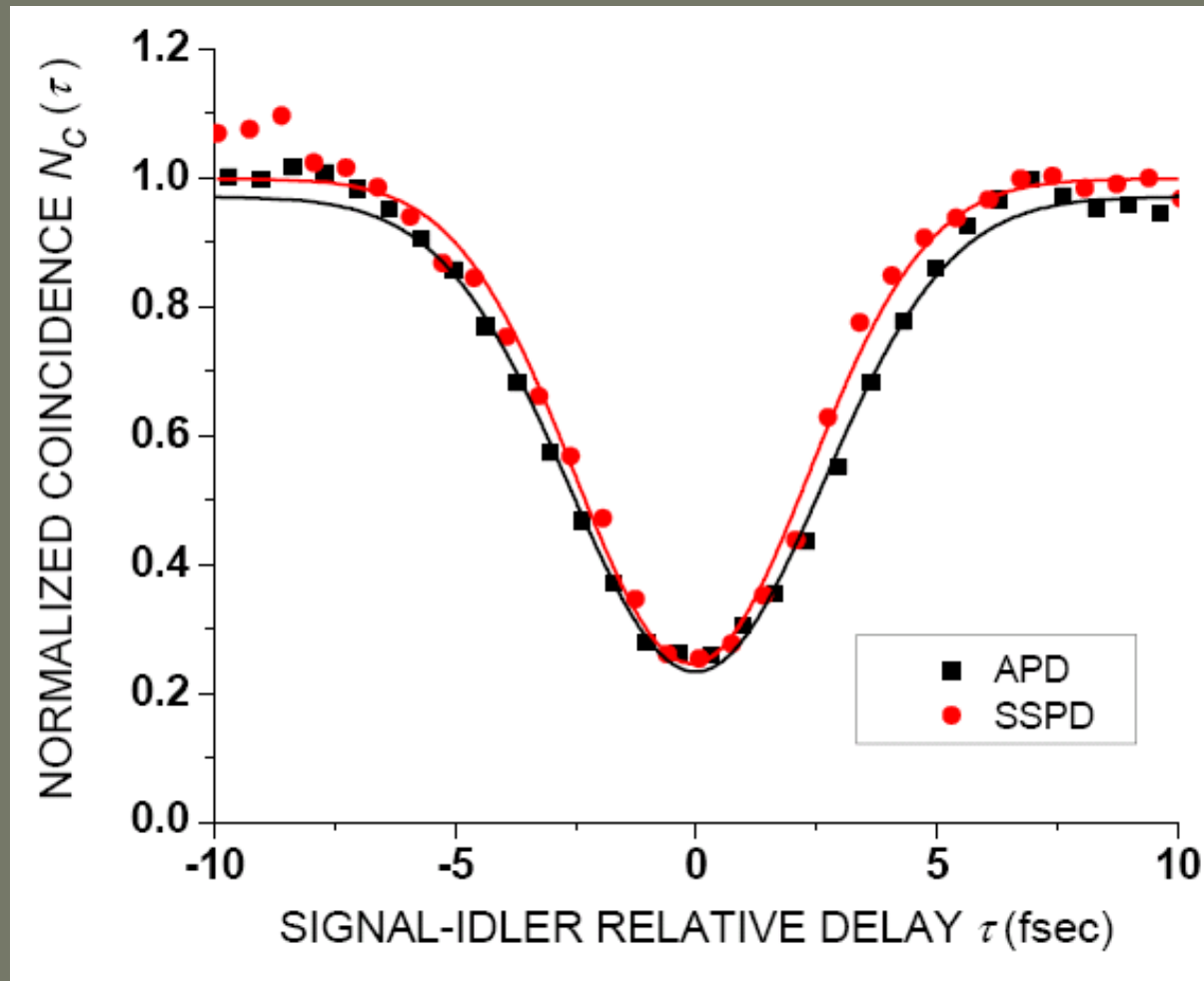
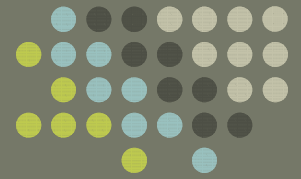

After Nasr, Minaeva, Goltsman, Sergienko, Saleh, and Teich, "Submicron Axial Resolution in an Ultrabroadband Two-Photon Interferometer Using Superconducting Single-Photon Detectors," *Opt. Express* **16**, 15104 (2008)

Quantum-Mimetics

Phase-Sensitive Optical Coherence Tomography

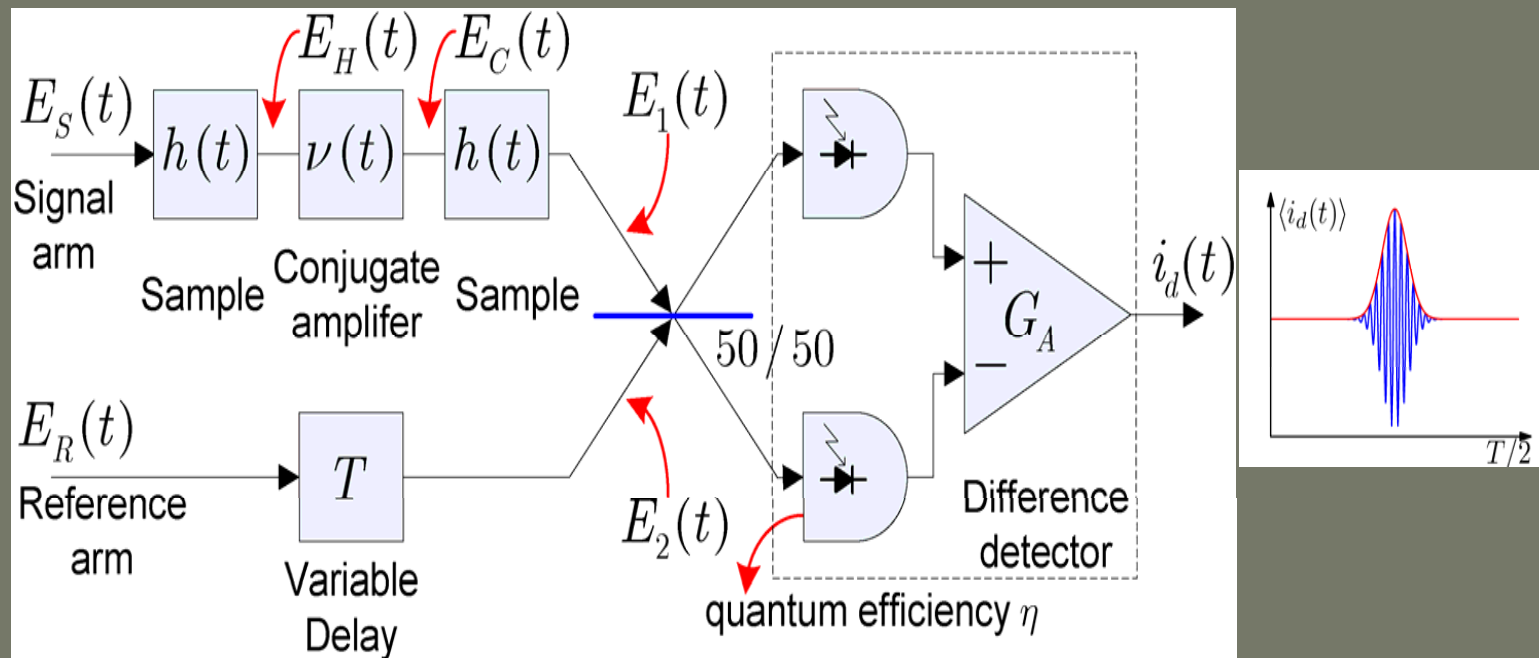

After B. I. Erkmen and J. H. Shapiro, "Phase-Conjugate Optical Coherence Tomography," *Phys. Rev. A* **74**, 041601 (2006)

Polarization-Sensitive OCT

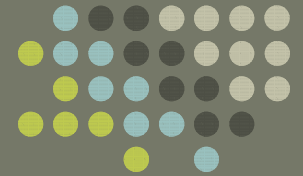

POLARIZATION
reveals the details

OCT →

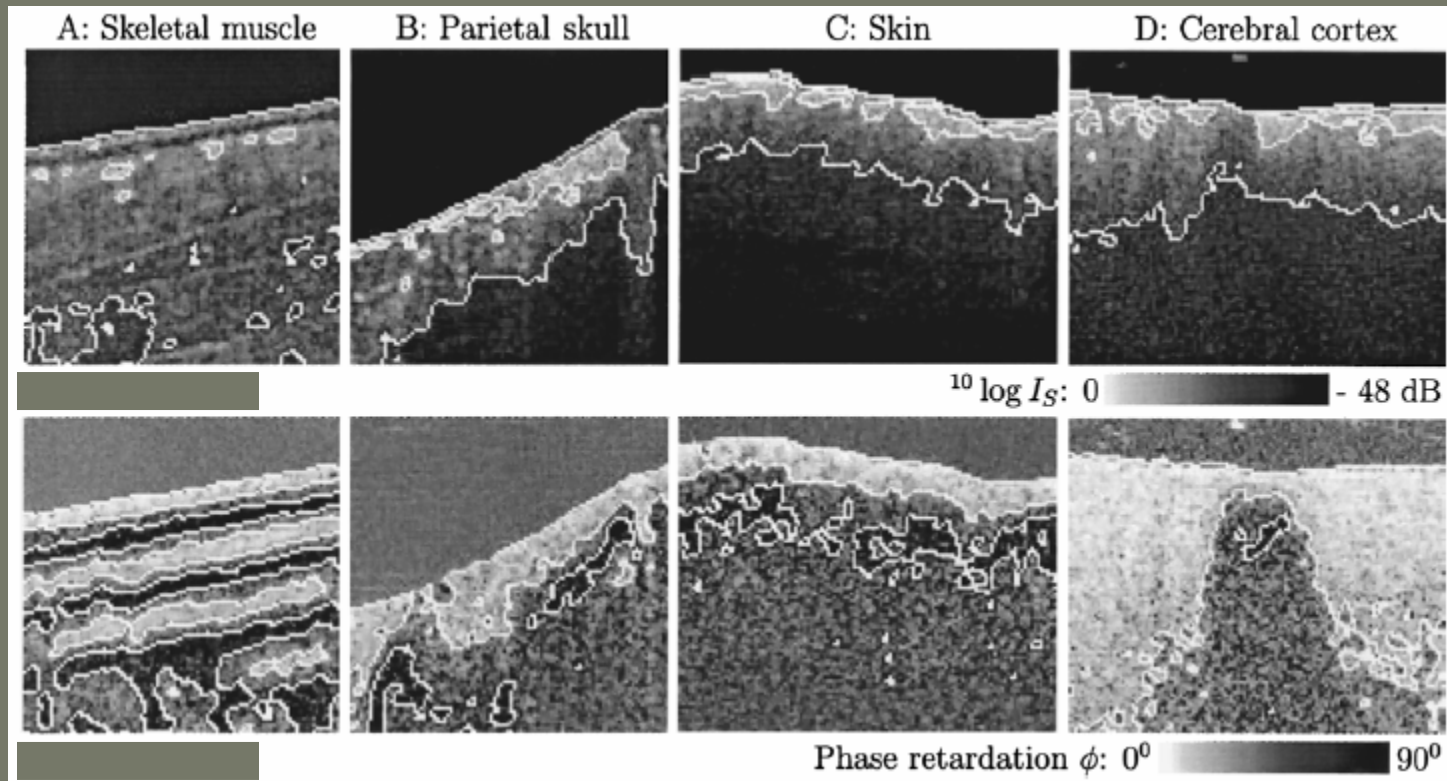

PS-OCT →

- TISSUES WITH COLLAGEN OR ELASTIN FIBERS, E.G. MUSCLE, TENDONS
- NORMAL AND THERMALLY DAMAGED SOFT TISSUE

Shuliang Jiao and Lihong Wang, *OE Magazine*, pp. 20- 22 (July 2003)

J. de Boer et al., *IEEE J. Select. Top. Quantum Electron.* **5**, 1200-1204 (1999)

Properties of Type-I and Type-II Entangled Photons

(a) TYPE-I SPDC

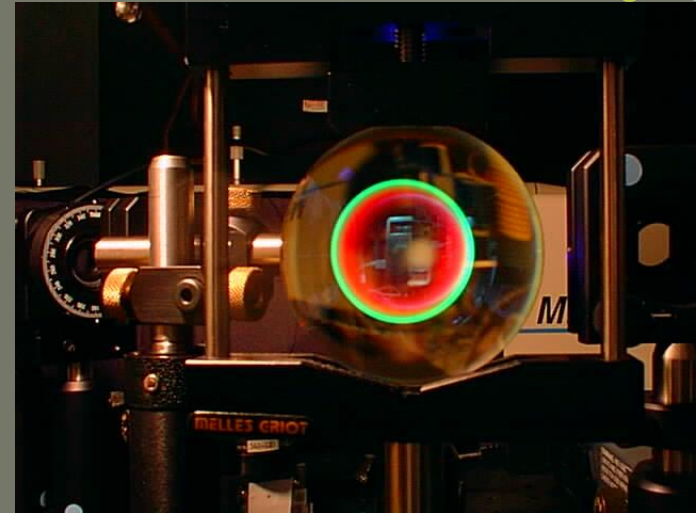
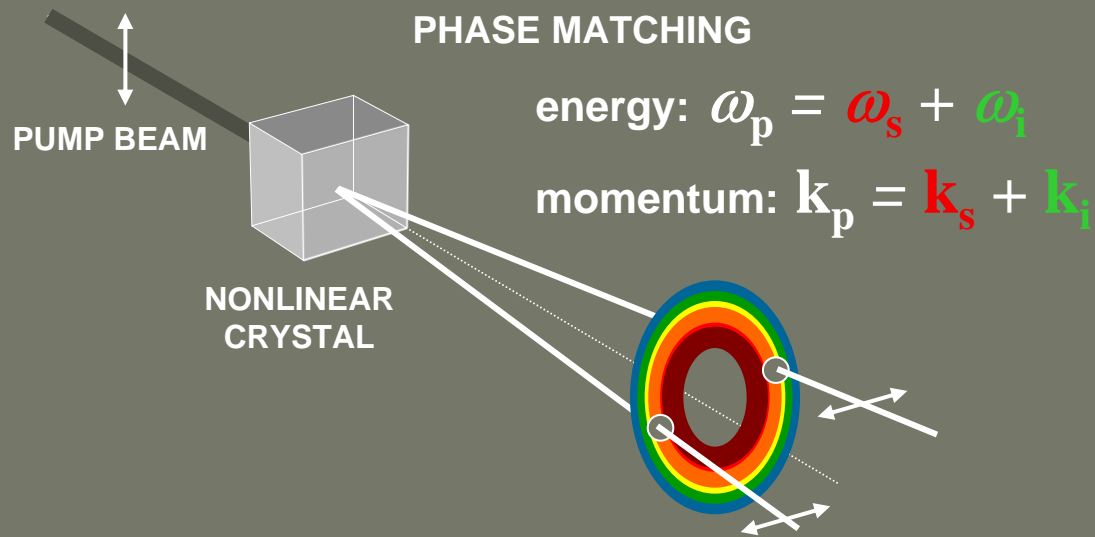

(b) TYPE-II SPDC

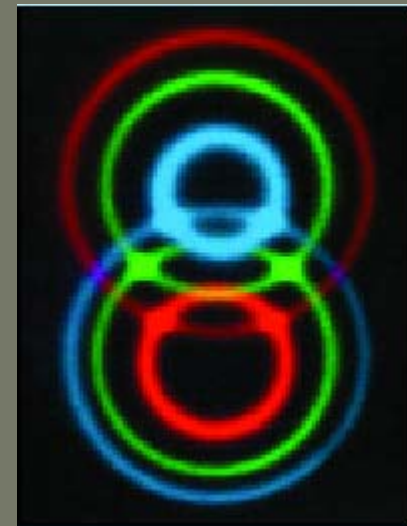
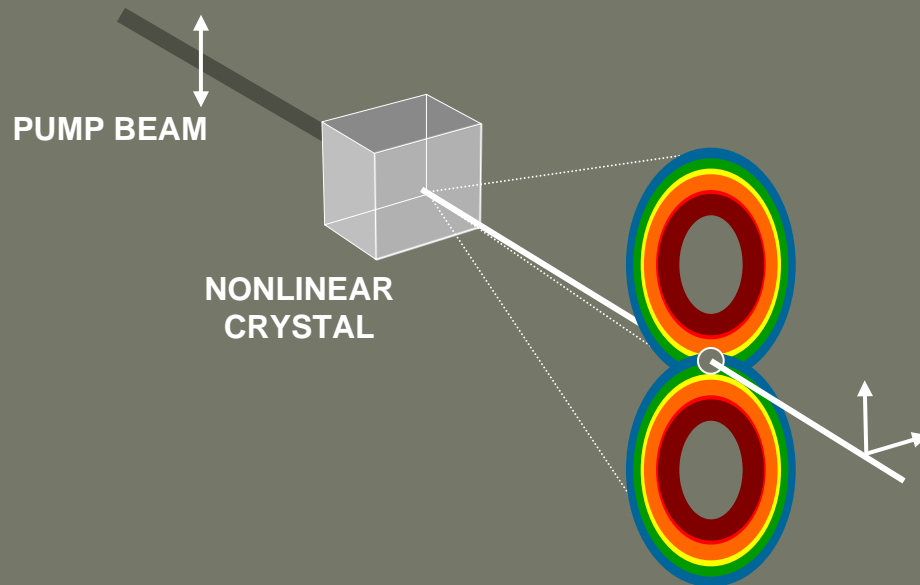

Polarization-Sensitive QOCT: Theory

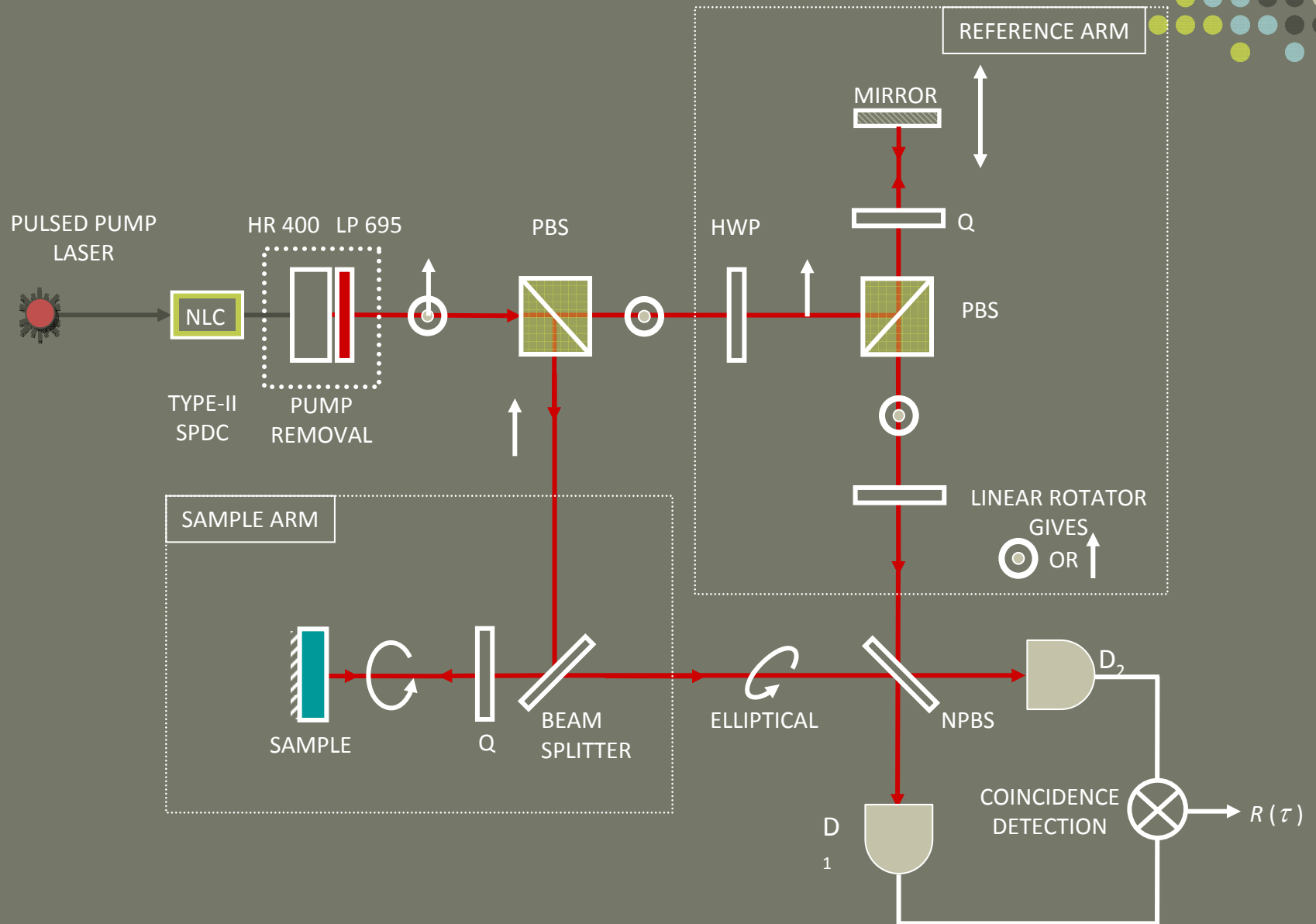

After Booth, Di Giuseppe, Saleh, Sergienko, and Teich, "Polarization-Sensitive Quantum-Optical Coherence Tomography," *Phys. Rev. A* **69**, 043815 (2004)

Polarization-Sensitive QOCT: Experiment

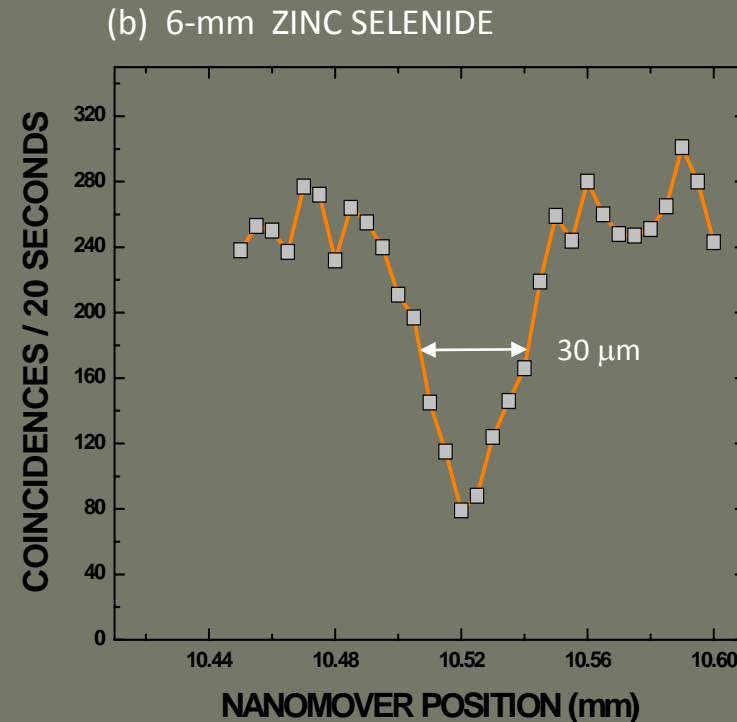
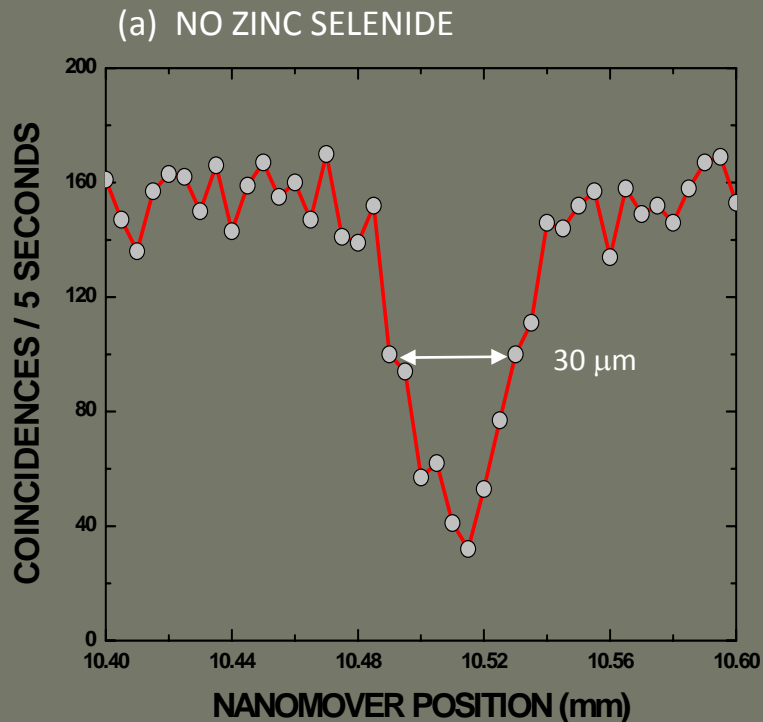

After Booth, Saleh, and Teich, "Polarization-Sensitive Quantum-Optical Coherence Tomography: Experiment," *Opt. Commun.* **284**, 2542 (2011)

Modal, Spectral, and Polarization Entanglement in Guided-Wave Parametric Downconversion

Co-propagating SPDC in waveguides

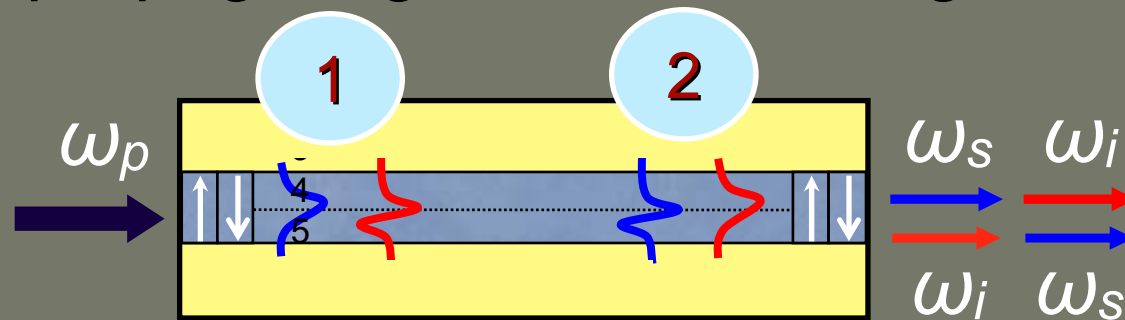

Direction \longrightarrow Waveguide modes

Phase mismatching

$$\Delta\beta_1 = \beta_p^{(m_p)} - \beta_s^{(0)} - \beta_i^{(1)}$$

$$\Delta\beta_2 = \beta_p^{(m_p)} - \beta_s^{(1)} - \beta_i^{(0)}$$

Modal Entanglement

In general, by controlling waveguide dimensions

$$\Delta\beta_1 \neq \Delta\beta_2$$

$$\Delta\beta_1 = \Delta\beta_2 \longrightarrow \Lambda_1 = \Lambda_2$$

Single poling period

After Saleh, Saleh, and Teich, "Modal, Spectral, and Polarization Entanglement in Guided-Wave Parametric Down-Conversion," *Phys. Rev. A* **79**, 053842 (2009)

Modal, Spectral, and Polarization Entanglement in Photonic Circuits



Example: Modal entanglement of nondegenerate photons via frequency separation

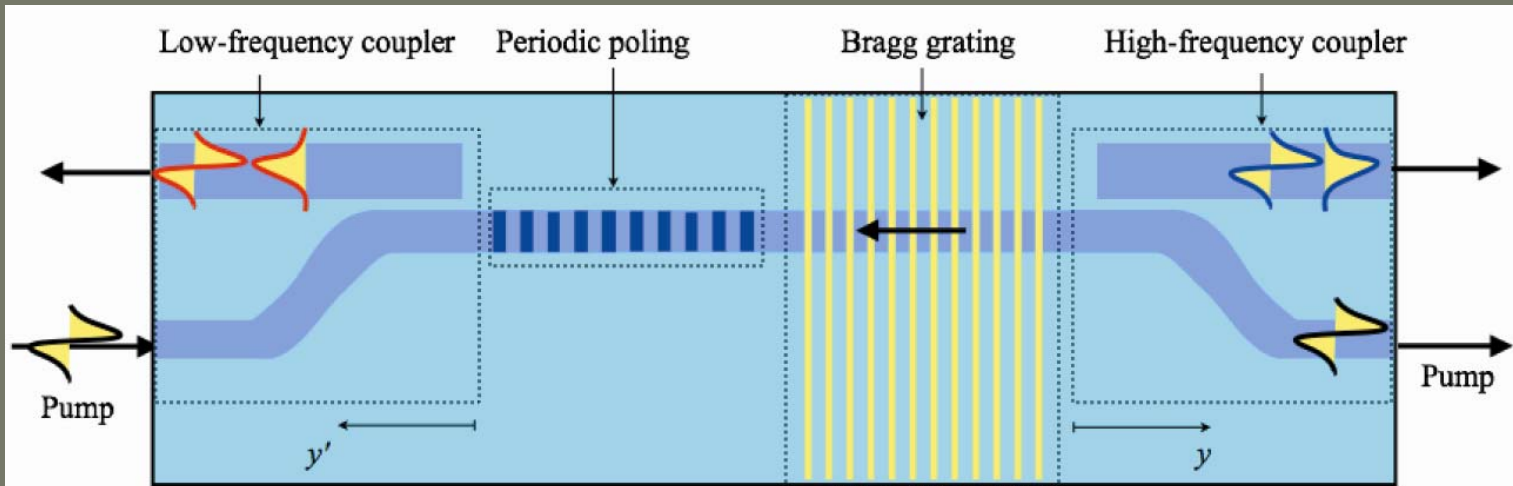

(a)

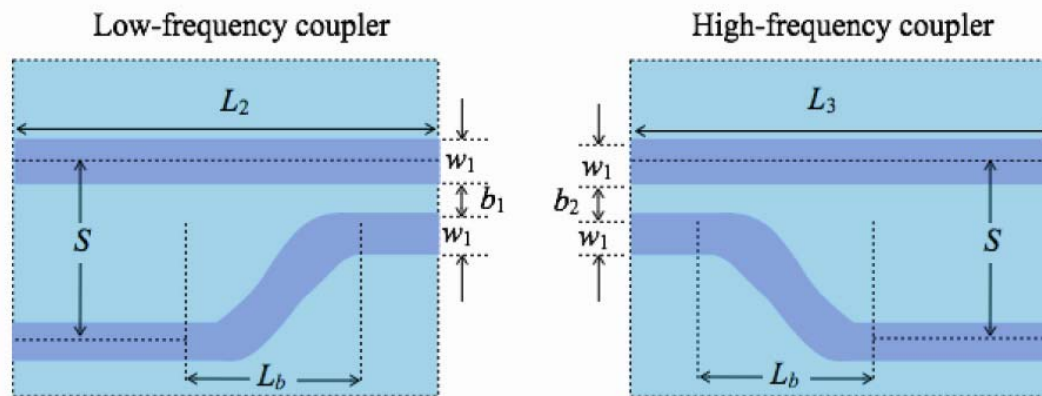

(b)

After Saleh, Di Giuseppe, Saleh, and Teich, "Photonic circuits for generating modal, spectral, and polarization entanglement," *IEEE Photonics Journal* 2, 736 (2010)

Biphoton Compression Can Make Entangled-Photon Photoemission, Microscopy, and Lithography Work

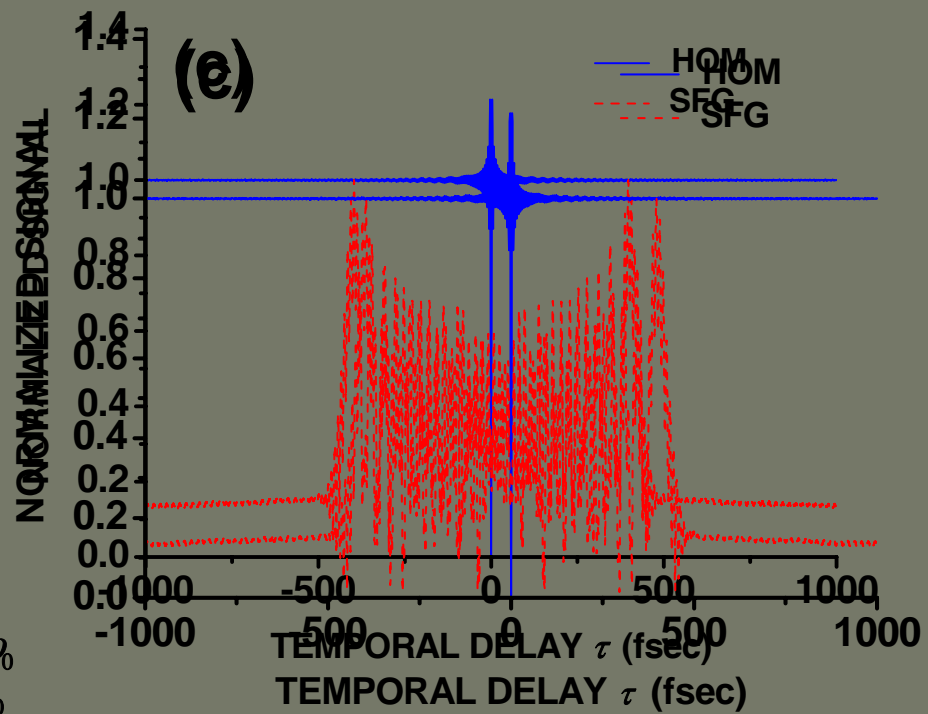
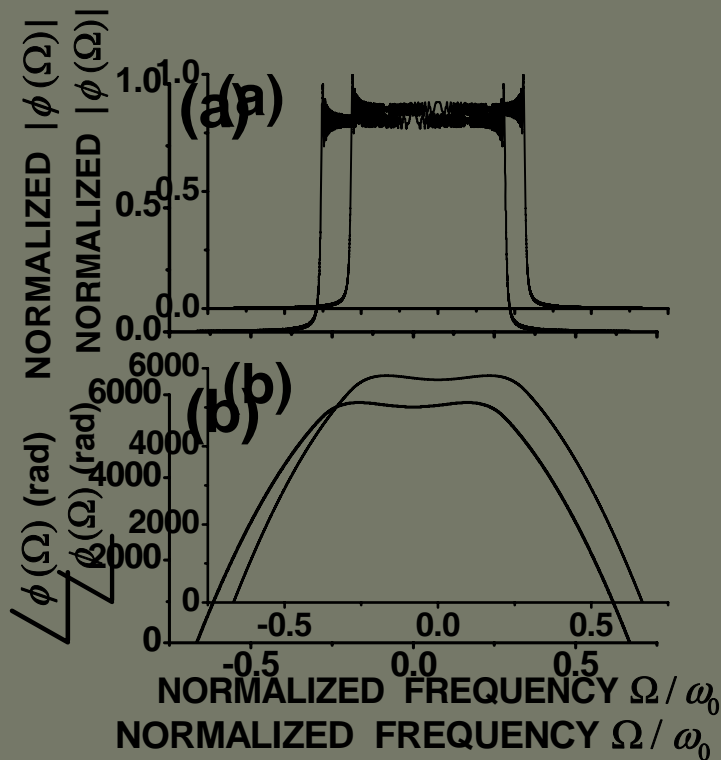

After Nasr, Carrasco, Saleh, Sergienko, Teich, Torres, Torner, Hum, and Fejer, "Ultrabroadband Biphotons Generated via Chirped Quasi-Phase-Matched Optical Parametric Down-Conversion," *Phys. Rev. Lett.* **100**, 183601 (2008)

ACKNOWLEDGMENTS

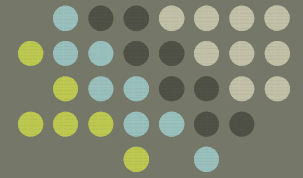

Boston University:

- Ayman Abouraddy
- Mark Booth
- Francesco Lissandrin
- Nishant Mohan
- Olga Minaeva
- Julie Praino
- Mohammed Saleh
- David Simon
- Jason Stewart
- Andrew Whiting
- Tim Yarnall

- Giovanni Di Giuseppe
- Martin Jaspan
- Boshra Nasr

University of Maryland- College Park:

- John Fourkas
- Rick Farrer
- Chris LaFratta

Institut de Ciències Fotòniques:

- Silvia Carrasco
- Juan Torres
- Lluís Torner

Stanford University:

- David Hum
- Martin Fejer

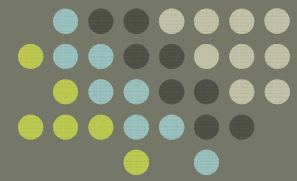

*Army
Research Office*

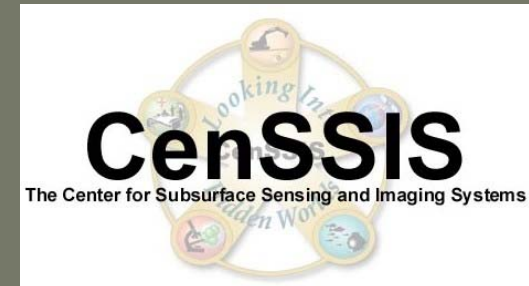

The David and Lucile Packard Foundation

